

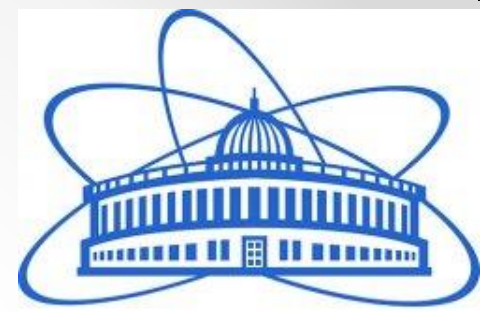

UNIVERZITA PAVLA JOZEFA ŠAFÁRIKA V KOŠICIACH  
Prírodovedecká fakulta



JOINT INSTITUTE  
FOR NUCLEAR RESEARCH

# $\eta$ -nuclei in the SCAN experiment

Katarína Michaličková

Dubna  
17. – 22. September 2018

XXIV International Baldin Seminar on High Energy  
Physics Problems.  
Relativistic Nuclear Physics & Quantum  
Chromodynamics.

# $\eta$ -meson nucleus

- $\eta$ -meson nucleus – bound state of  $\eta$ -meson and nucleus
- Short lifetime  $\tau_\eta = 5,5 \cdot 10^{-19}$  s, study of  $\eta$ -nucleon interaction ( $\eta N$ ) is based on study of scattering amplitude  $\eta N$  for processes:

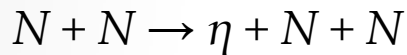
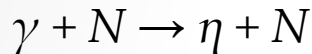
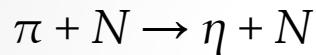

- $\eta N$  interaction near threshold is mainly determined by the  $S_{11}(1535)$  resonance, which is just 49 MeV above the  $\eta N$  threshold and has a width  $\Gamma \approx 150$  MeV
- Mass of  $S_{11}(1535)$  resonance is very close to threshold of  $\eta N$  production ( $\eta N_{\text{threshold}} = m_\eta + m_N \approx 1486$  MeV)
- $S_{11}(1535)$  is unstable:  
 $S_{11}(1535) \rightarrow \pi + N$   
 $S_{11}(1535) \rightarrow \eta + N$   
 $S_{11}(1535) \rightarrow \pi + \pi + N$

# Mechanism of $\eta$ -nucleus formation

- $\eta + N \rightarrow S_{11}(1535) \rightarrow \eta + N \rightarrow S_{11}(1535) \rightarrow \dots \rightarrow S_{11}(1535) \rightarrow \dots \rightarrow \pi + N$

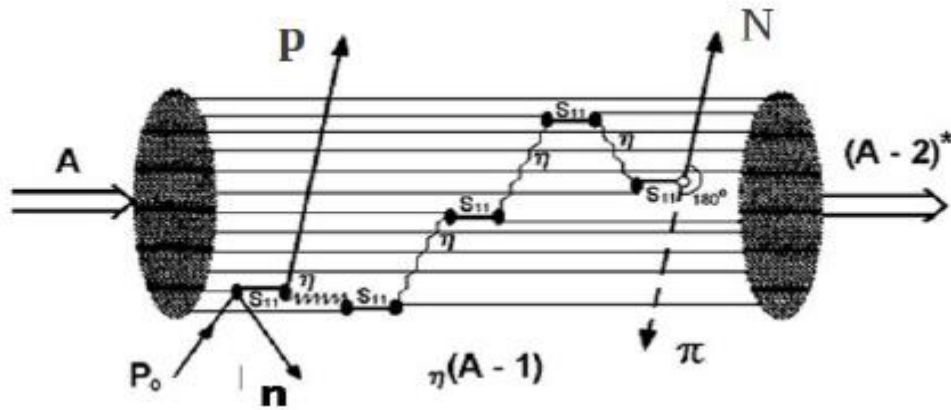

- $p_0 + A \rightarrow N_1 + N_2 + \eta(A-1)$   
 $\eta(A-1) \rightarrow \pi + N_3 + (A-2)$



SCHÉMA REAKCIE, V KTOREJ JE FORMOVANÉ  $\eta$ -MEZÓNOVÉ JADRO



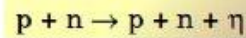
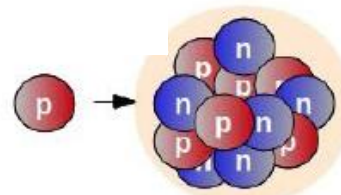
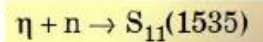
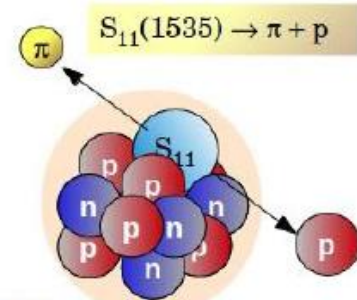
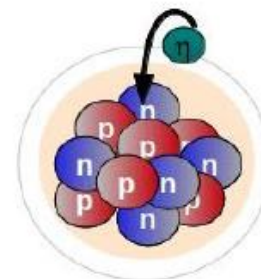
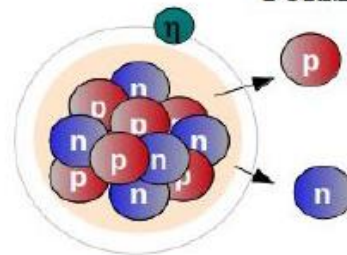

# Experimental data

Initial particles: deuterons

Target: Carbon

39. run – not constant magnetic field

The main task of processing these data is to calculate the minimum energy needed to create eta-nuclei.

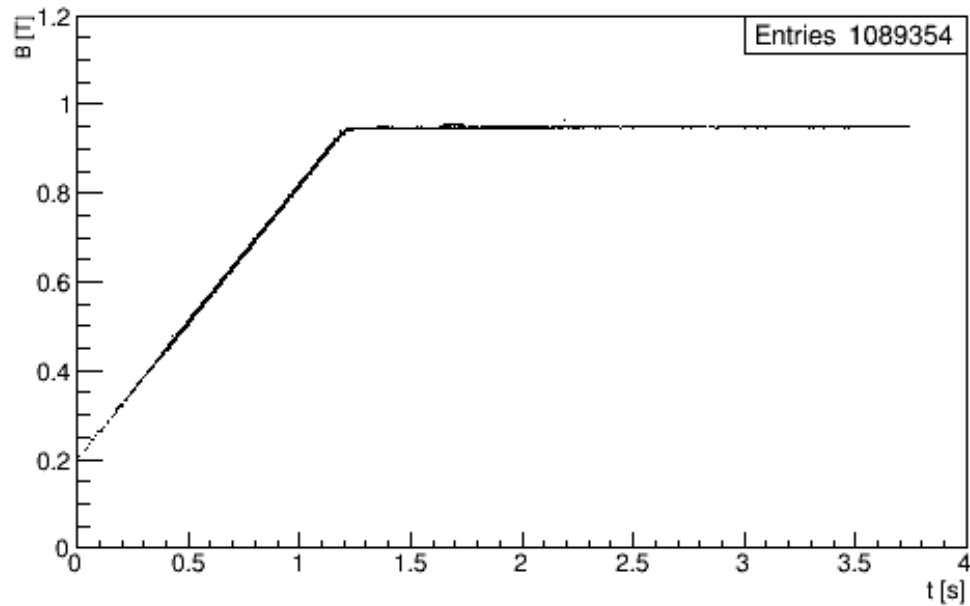

Dependence of kinetic energy of initial deuterons on magnetic field:

$$T = \sqrt{m_d^2 + (0.3BZR)^2} - m_d$$

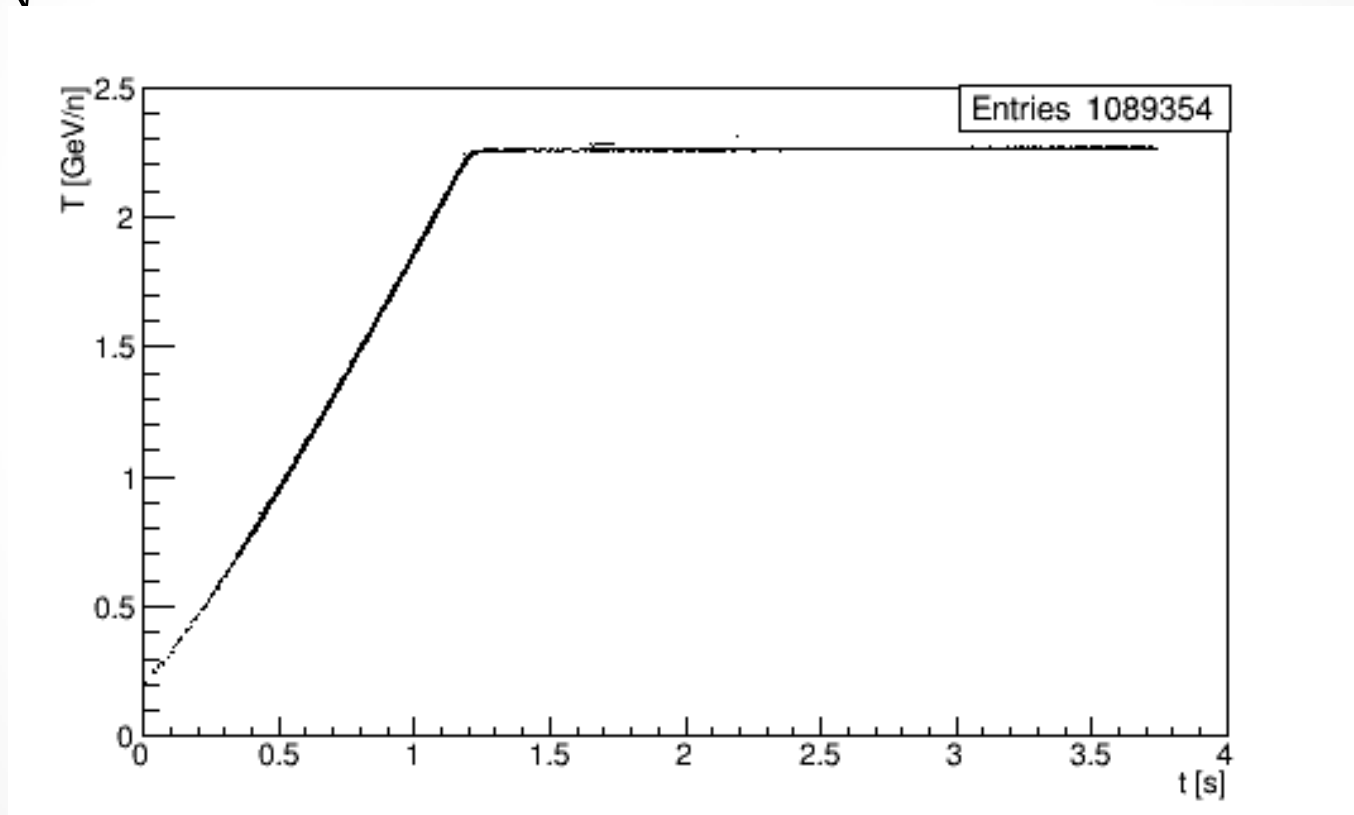

Maximum  $T_d = 2.3$  GeV/nukl

# Determination of minimum energy to create $\eta$ -nuclei – detection $\pi\pi$ pair:

- energy spectrum of protons for different kinetic energy intervals of deuterons.

- if protons are from  $\eta$ -nuclei decay – observed resonance - the second peak should be seen in value 90 MeV

$$\text{minimal } T_d = 0.8 \text{ GeV/nukl}$$

-> need to increase statistics and make corrections

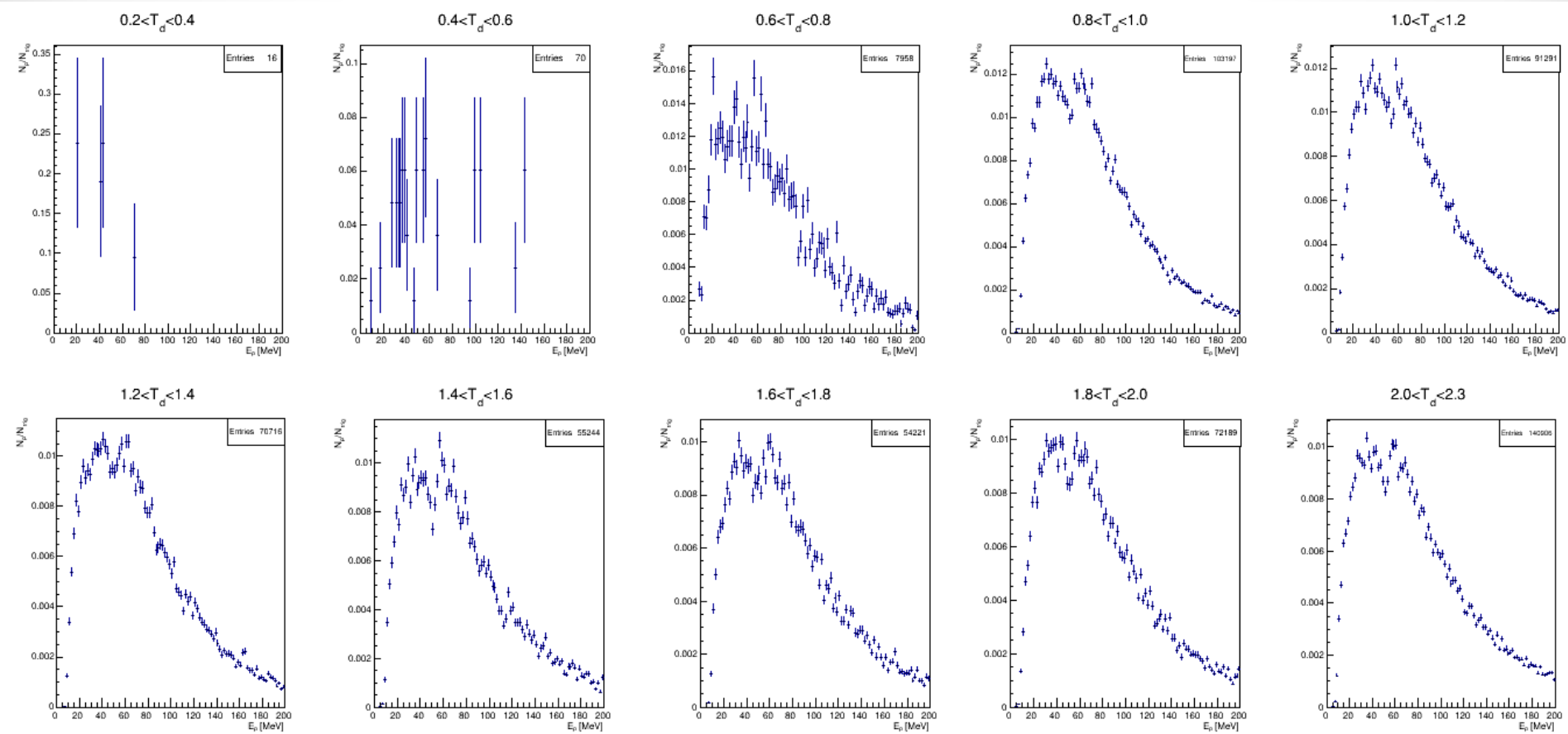

# SCAN 3

- SCAN2 problems : charge identification of pions
- background at  $170^\circ$
- only  $p\pi$  channel

## SCAN3

- Three-arm spectrometer
- Analyzing magnet – identif. of charged particles
- P/K arm TOF spectrometers – p, n
- Background at  $90^\circ$
- Neutron detector – study of new decay channels with neutrons

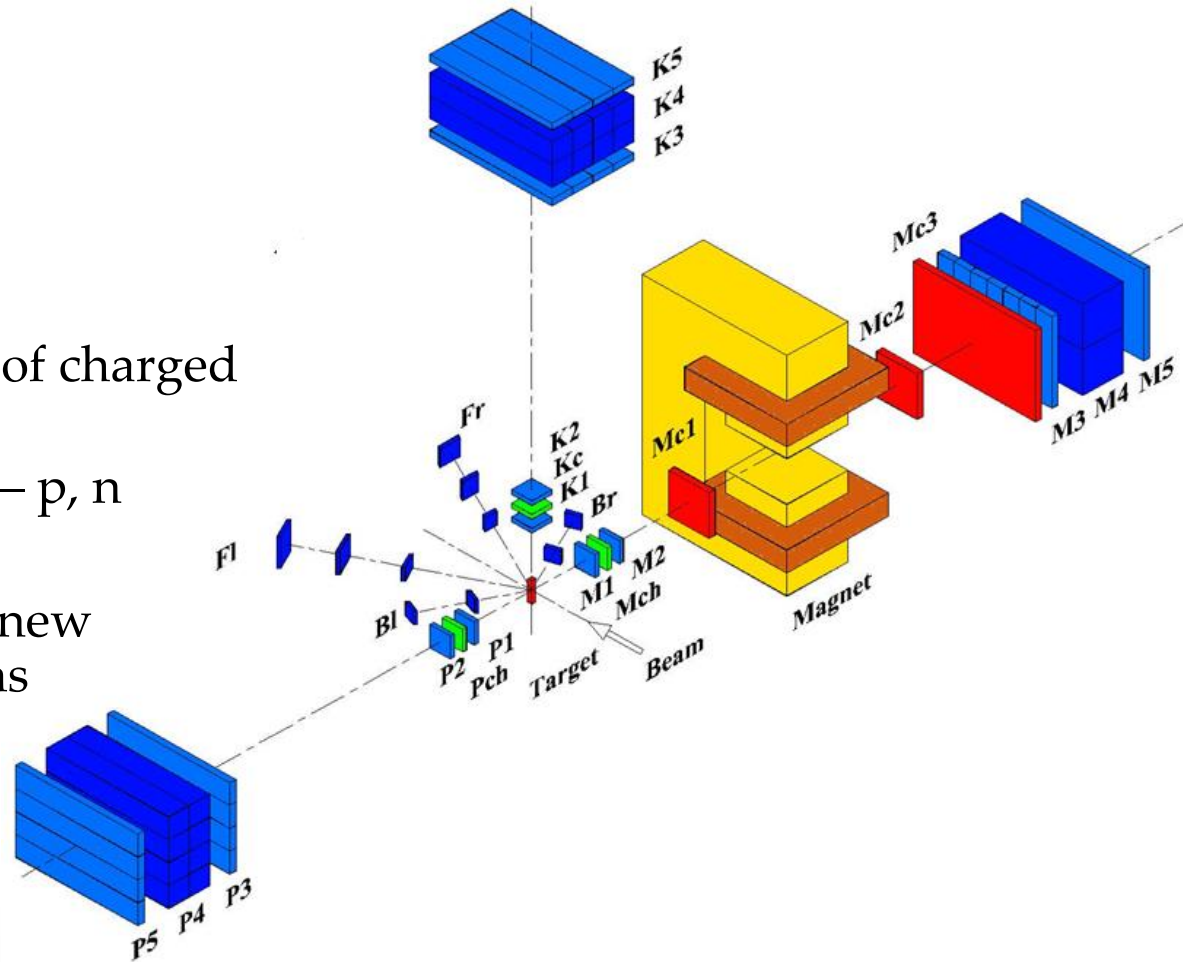



# Neutron detector

Deuteron beam:  $E_d = 3\text{GeV/nukl}$  using Nuclotron

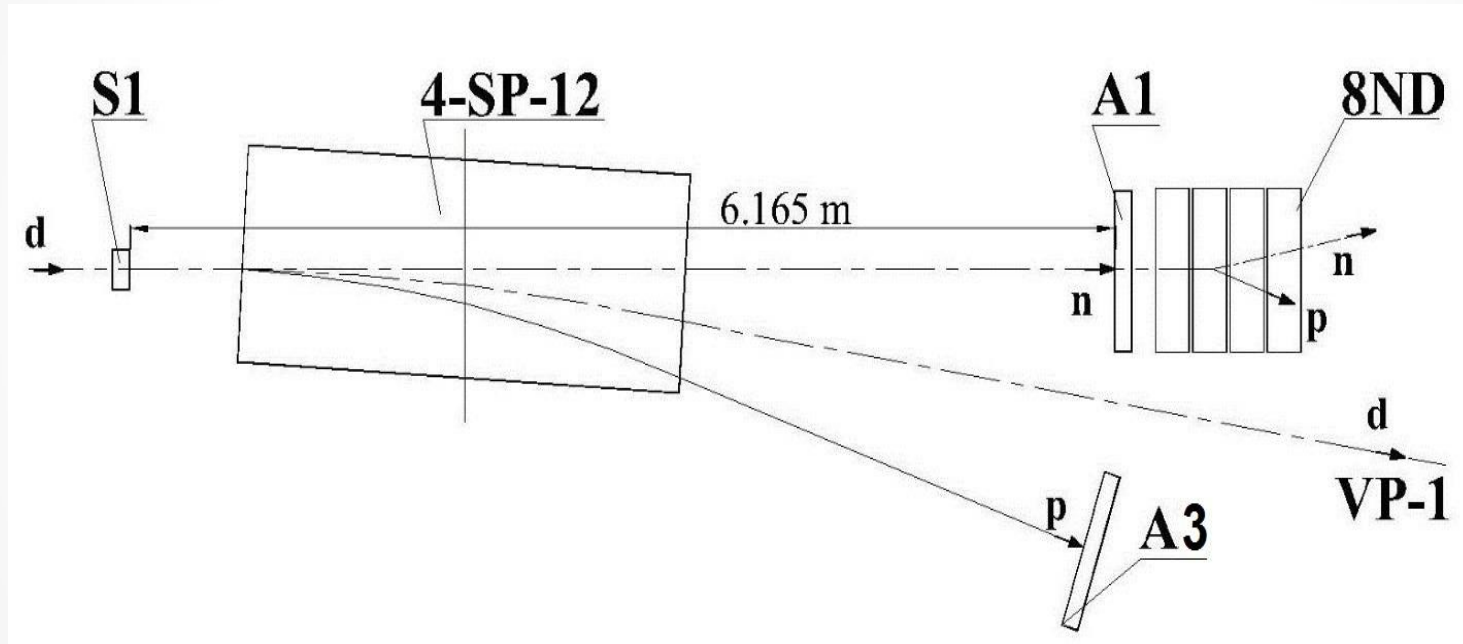

To test the neutron detector, a deuteron stripping reaction on fixed target to obtain neutron beam was used.

# Idea of experiment:

Method „time-of-flight“ (TOF):

- Neutrons flying through the detector layers at some point collides with the proton of the material and then knock out it from this material.
- If the charged particle starts moving in the scintillator, the counter is running.
- Depending on the length of the flight and the arrival time of the signal from the interaction point to the counter, it is possible to estimate the velocity and energy of the neutron.

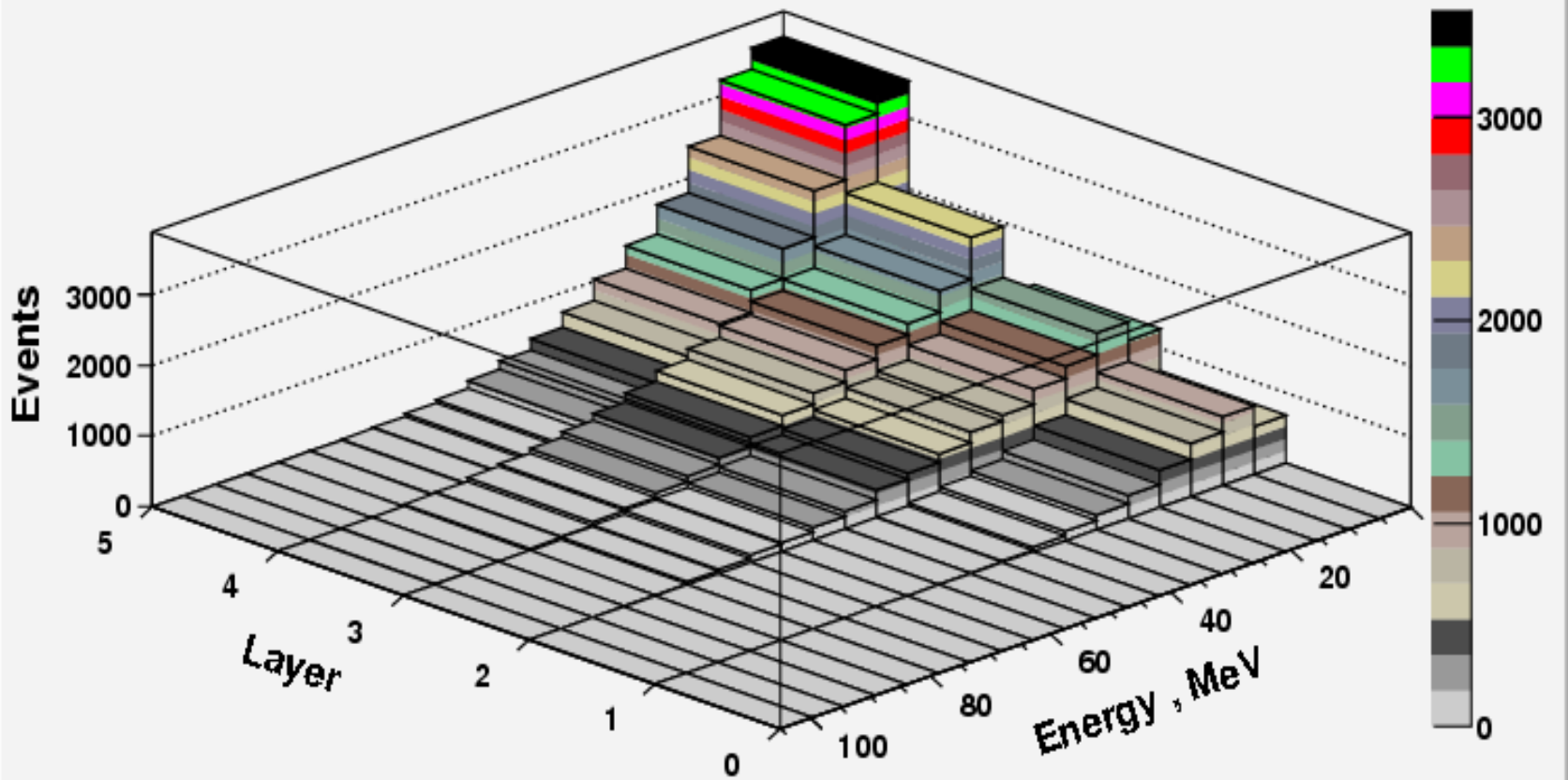

- Distribution of energy losses of neutrons in each layer and number of signal depending on the layer.
- The most of neutrons interact in the 4. layer of the detector and the number of events decreases with increasing neutron energy.

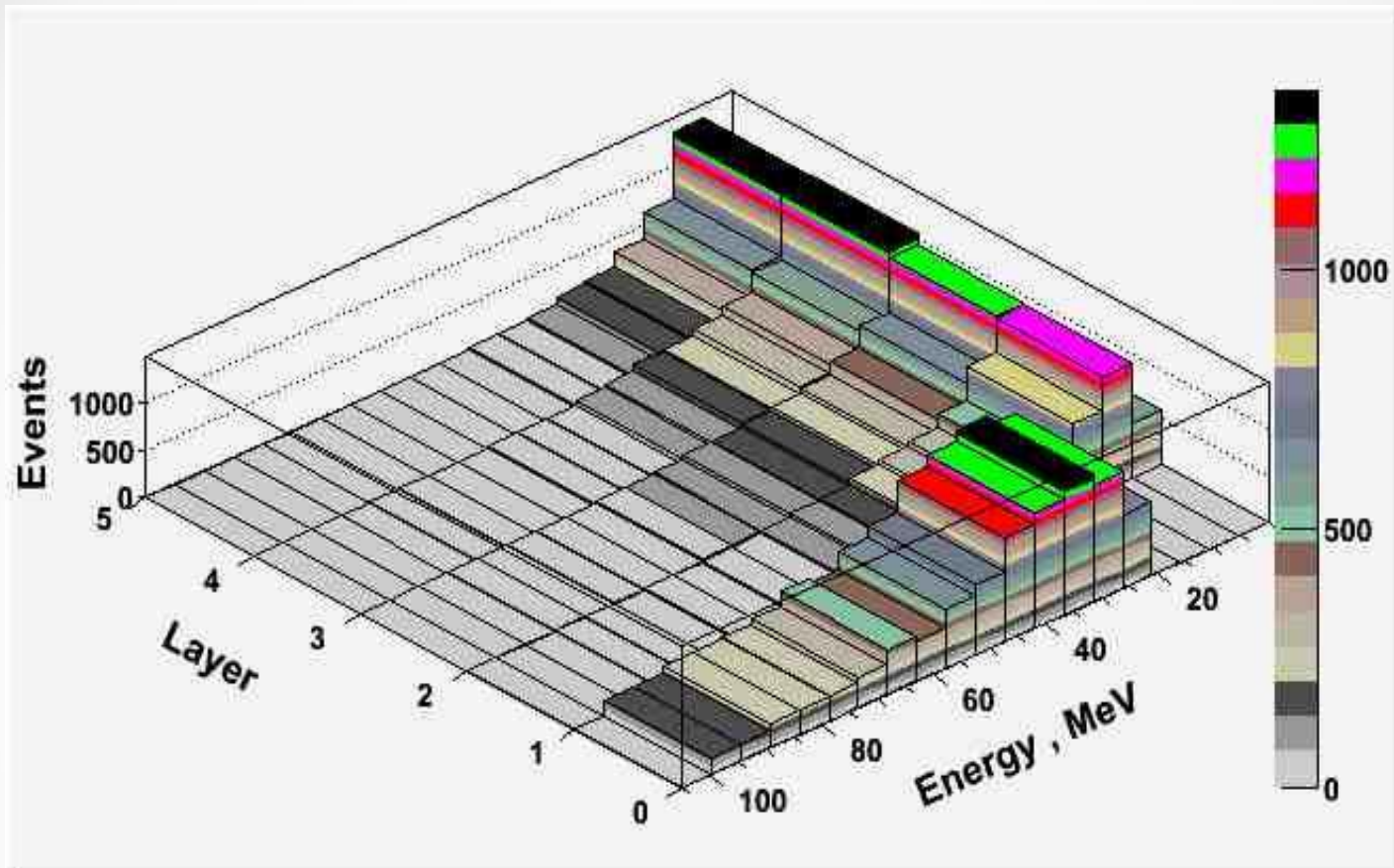

- If charged particles fly in range of detector, almost all of the energy is released in the first layer.

## Time resolution for two closest layers

$N_i-N_k$	$N_1-N_3$	$N_3-N_5$	$N_5-N_7$	$N_2-N_4$	$N_4-N_6$	$N_6-N_8$
$\sigma$ [ns]	0.27	0.27	0.3	0.44	0.3	0.2

Efficiency of neutron detector: 27 % for 4 scintillation layers

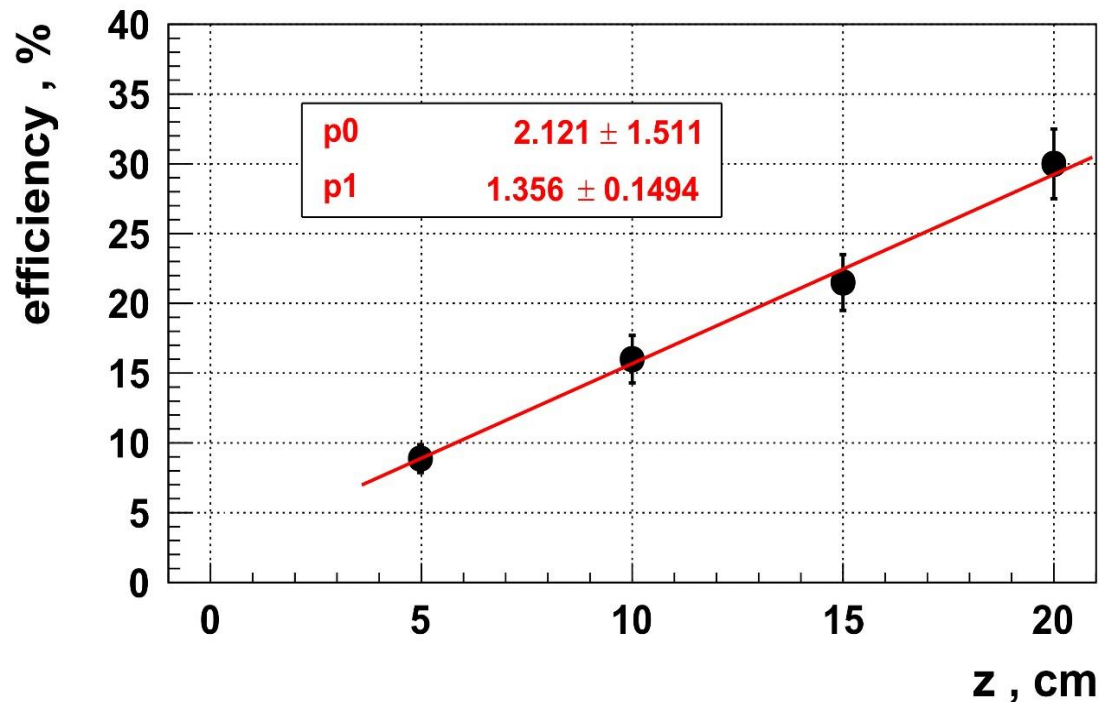

End of September:

Test of new Neutron detector with 5 layers of scintillator, which are ready now. For test will be used cosmic rays.

# Conclusions

- The dependence of kinetic energy on magnetic field was calculated - maximum energy of deuteron beam is 2.3 GeV/nucleon.
- Determination of the minimum energy for  $\eta$ -nuclei formation: 0.8 GeV/nucleon.
- The first prototype of the neutron detector was investigated.
- Detection efficiency of neutrons using four layers is 27%.
- This detector can be used for its time resolution in the experimental setup SCAN3 for recording neutrons in  $\pi n$  and  $p n$  decay channels of the  $\eta$ -nucleus.

# Thank you for attention

ACKNOWLEDGMENT: This research was supported by the Ministry of Education, Science, Research, and Sport of the Slovak Republic (VEGA Grant No. 1/0113/18).