

Draft

# **SEVEN-YEAR PLAN FOR THE DEVELOPMENT OF JINR FOR 2024–2030**

**Dubna 2023**

## CONTENTS

PREFACE.....	3
INTRODUCTION .....	4
DEVELOPMENT OF A LARGE JINR RESEARCH INFRASTRUCTURE .....	9
ELEMENTARY PARTICLE PHYSICS AND HIGH-ENERGY HEAVY-ION PHYSICS .....	23
NUCLEAR PHYSICS .....	30
CONDENSED MATTER PHYSICS.....	36
RADIATION RESEARCH IN LIFE SCIENCES .....	42
THEORETICAL PHYSICS.....	45
INFORMATION TECHNOLOGY .....	47
PHYSICS AND TECHNOLOGY OF CHARGED PARTICLE ACCELERATORS.....	49
DEVELOPMENT OF ENGINEERING INFRASTRUCTURE.....	51
INNOVATION ACTIVITIES .....	55
STRENGTHENING HUMAN RESOURCES .....	58
ORGANIZATION OF SCIENTIFIC ACTIVITY.....	62
DEVELOPMENT OF SCIENTIFIC COMMUNICATION.....	65
DIGITALIZATION OF ADMINISTRATIVE AND MANAGEMENT ACTIVITIES.....	67
DEVELOPMENT OF SOCIAL INFRASTRUCTURE .....	68
FINANCIAL SUPPORT .....	70
RISK ASSESSMENT.....	75
MONITORING THE IMPLEMENTATION OF SEVEN-YEAR PLAN AND LONG-TERM DEVELOPMENT STRATEGY OF JINR.....	77

## **PREFACE**

## INTRODUCTION

Over the past decade, in the development of world science, the role of interdisciplinarity in natural science research has grown significantly, integrating, in terms of subject and research methods, in various diverse combinations, such areas of fundamental science as astronomy, physics, chemistry, life sciences, and ecology. The strengthening of this trend is associated both with the landmark achievements of certain areas of fundamental science, which opened up new prospects for interdisciplinary interaction, and with the growth of research infrastructure and, most importantly, with the revolutionary rapid development of IT technologies. Interdisciplinary interaction in the natural sciences opens up qualitatively new opportunities for conducting applied research, which is in demand by the tasks of the socio-economic development innovative trajectory followed by the development strategies of states that are world scientific and technological leaders. The interdisciplinary nature of research imposes particularly stringent requirements on the level of collectivization of the efforts of a large number of scientists and scientific and technical specialists who are experts in certain areas of a wide range of scientific directions and technical disciplines. At the same time, achieving success in solving complex and large-scale problems of modern science necessarily implies active international scientific and technological cooperation. This context determines the extremely important place of multidisciplinary international research organizations on the global landscape of world science.

From the moment of its foundation, the Joint Institute for Nuclear Research was formed as a multidisciplinary international research centre, integrating the efforts of scientists from many countries in several basic areas of fundamental science, as well as in applied research. Over the past decade, the scientific infrastructure has been actively developed, large-scale and productive scientific research has been carried out in the field of astrophysics and elementary particle physics, relativistic heavy-ion physics, nuclear physics, condensed matter physics, radiation biology, information and computing technologies, theoretical and mathematical physics.

Forming the fundamental methodological basis for the natural sciences in general, these sections of science statutory for JINR occupy a priority position in the world scientific problems and the agenda for the development of a large research infrastructure, which can be seen, in particular, from the distribution of large scientific infrastructures according to three key characteristics shown in Fig. 1. The distribution also shows that modern projects in the field of fundamental sciences in most cases have accompanying programmes of applied research aimed at sustainable development goals, if only the main scientific objectives of the project allow this in principle. The main scientific infrastructure projects of JINR harmoniously complement the global landscape of mega-science infrastructure, assuming, along with the main goals in the field of fundamental research, the achievement of some sustainable development goals.

Draft Seven-Year Plan for the Development of JINR for 2024-2030 is prepared in accordance with the JINR Long-Term Development Strategic Plan up to 2030 and beyond<sup>1</sup>, approved by the Committee of Plenipotentiaries of the Governments of the JINR Member States in March 2021, taking into account the recommendations of the international Working Group on Strategic Issues of JINR developed in the second half of 2021. The main goal of the Plan is to form a long-term scientific research programme and increase intellectual human capital, provided with optimal infrastructural and financial resources.

---

<sup>1</sup> JINR Long-Term Development Strategic Plan up to 2030 and Beyond. – Dubna: JINR, 2021. ISBN 978-5-9530-0551-7

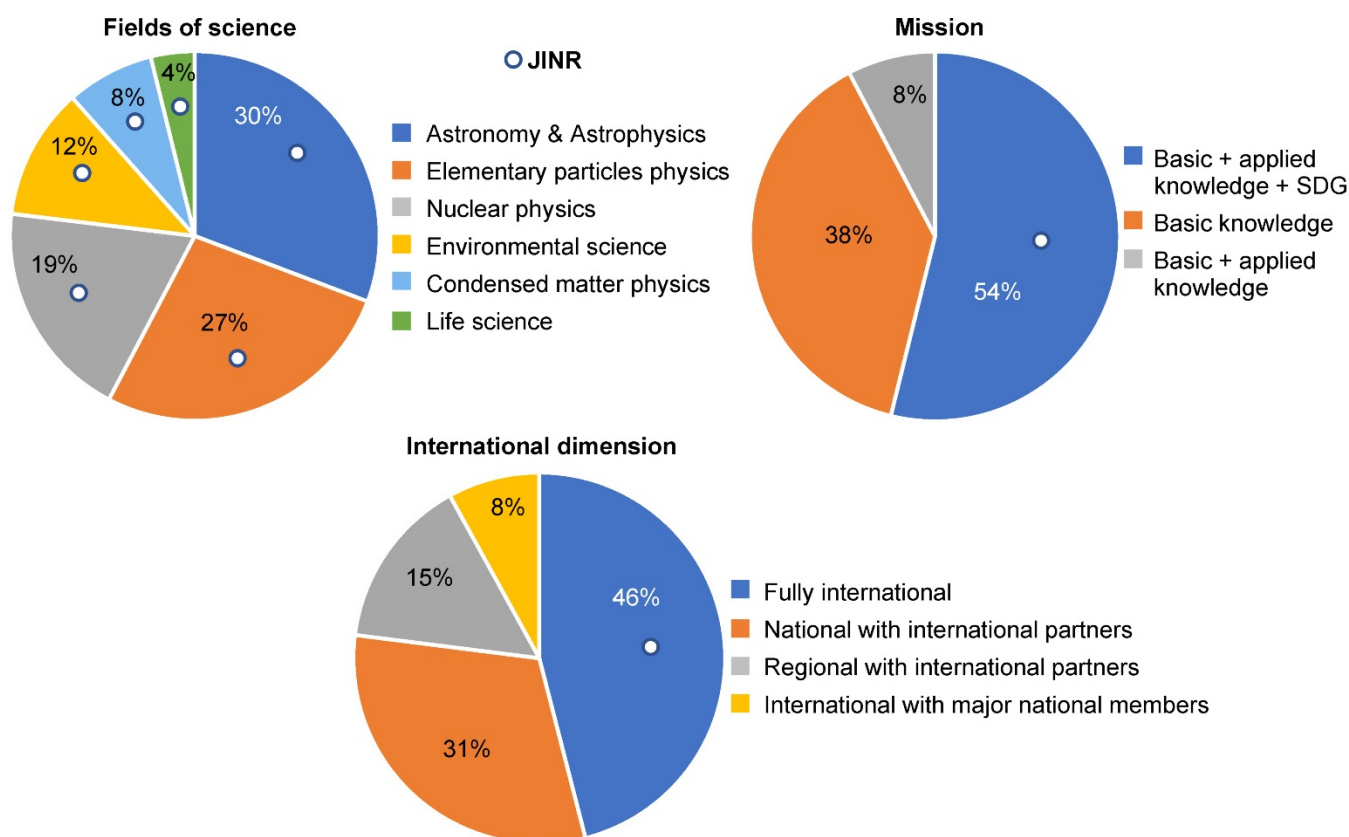

**Fig. 1.** Distribution of large research infrastructure projects by areas of science, mission and level of internationality. The sample includes 23 large research infrastructures of fundamental science, in particular the NICA complex, in a wide range of scientific areas that meet the criteria for a large research infrastructure (complexity, scale, uniqueness, mission), both operating/under construction and the planned ones, in accordance with the OECD report “Very Large Research Infrastructures: Policy Issues and Options”<sup>2</sup>, as well as three more JINR-based large research infrastructures added to our analysis – SHE Factory, IBR-2 and Baikal-GVD

The overall goal of the Institute's development strategy is a leading position at the forefront of science in a number of selected areas of fundamental research. To provide infrastructure for achieving this goal, the Institute already has or will create several research infrastructure facilities, including mega-class ones:

- Factory of Superheavy Elements;
- infrastructure for research on a fixed target and in the collider mode for heavy-ion collisions at the NICA complex;
- infrastructure for spin physics studies on polarized beams at the NICA complex;
- future objects within the further development of the NICA complex after 2030-2035 (electron-ion collider, supercritical Coulomb fields, proton source for research in the field of neutrino physics);

<sup>2</sup>OECD Science, Technology and Industry Policy Papers. July 2023. No. 153: Very Large Research Infrastructures: Policy Issues and Options. <https://doi.org/10.1787/2b93187f-en>

- Baikal-GVD neutrino telescope and its further development for research in the field of multichannel astronomy, study of the fundamental properties of the most energetic cosmic neutrinos, indirect search for galactic “dark” matter and applied research;
- IBR-2 pulsed neutron source with a set of spectrometers;
- a new pulsed neutron source based on the NEPTUNE high-intensity pulsed neutron reactor with Np-237 in the core;
- irradiation facilities for research in the field of materials science and radiation biology;
- Innovative Centre for nuclear physics research;
- a dynamically developing IT platform based on the JINR Multifunctional Information and Computing Complex (MICC), including, in particular, a hyperconverged system – the “Govorun” supercomputer, to provide the analysis, processing and storage of data from JINR research programmes.

The implementation of the scientific programme presented in this Plan will be mainly based on experimental studies using the above-mentioned JINR basic facilities, carried out by research teams from the JINR Member States and international collaborations. Particular attention will be paid to the development of user programmes at IBR-2 and MICC, the formation of all-Institute interdisciplinary projects in the field of radiation research.

In addition, the Institute intends to continue its participation in advanced external experiments in the relativistic heavy-ion physics, particle physics and neutrino physics, provided that the potential for discoveries in these experiments is high, JINR researchers can play a leading role, and partner scientific organizations show mutual interest in strengthening cooperation. The proposed Plan provides for continued participation in experiments at the world's accelerator centres and in neutrino experiments. Preference is given to close cooperation on the detector and accelerator projects of JINR with CERN, GSI, DESY and on future large-scale facilities, FAIR in Germany, BNL and FNAL in the USA, GANIL in France, and some others.

### **Science Programme Priorities**

**In the field of elementary particle physics and new physics beyond the Standard Model**, research will be carried out within the framework of the NICA-SPD project and JINR participation in international collaborations at LHC (ATLAS, CMS, ALICE), COMPASS/AMBER at SPS, BES-III, COMET at J-PARC, etc.

**In the field of flavor physics**, research on the flavor physics of quarks and charged leptons will be continued by participating in international experiments to study rare kaon decays and search for the conversion of muons into electrons on nuclei ( $\mu 2e$  and COMET).

In **perturbative** and **nonperturbative** QCD, the main tasks will be the preparation of the programme and research of the NICA-SPD project, as well as JINR's participation in the most important international collaborations (COMPASS/AMBER, BESIII, PANDA).

**The JINR research programme in the field of neutrino physics and astrophysics** is focused on fundamental problems of astrophysics and elementary particle physics: identification of astrophysical sources of ultrahigh-energy neutrinos, mechanisms of formation and evolution of galaxies, determination of the neutrino mass hierarchy, origin of the neutrino mass, constraints on the CP-violation phase, direct search for dark matter, precision study of coherent elastic scattering of neutrinos on nuclei, etc. The

programme includes research in neutrino physics and astrophysics at the JINR basic facility – the unique neutrino telescope Baikal-GVD, fundamental and applied research on antineutrino beams at the Kalinin Nuclear Power Plant, participation in international neutrino experiments (JUNO, SuperNEMO, NOvA/DUNE, GERDA-LEGEND, EDELWEISS-RICOCHET,  $\nu$ GEN (GEMMA-III), EURICA, DarkSide, TAIGA), as well as the development at JINR of an advanced research infrastructure necessary for these studies.

**In relativistic heavy-ion physics**, a promising experimental programme at JINR is associated with the NICA megaproject, whose task is to study hot and dense strongly interacting QCD matter, as well as to search for a mixed phase and a critical point in the QCD phase diagram in order to shed light on a poorly studied region of the phase diagram and to test predictions of nonperturbative QCD and other theoretical models describing strongly interacting matter. After the commissioning of the basic configuration of the NICA collider complex, at the BM@N and MPD experimental facilities, the implementation of a physics programme to study hot and dense baryonic matter and phase transformations in it will begin. The energy range of the NICA collider is of particular interest, since it corresponds to the maximum possible density of baryons at the time of their "freezing out". In this energy range, the system occupies the maximum amount of space-time in the form of a mixed phase of quark-gluon matter (coexistence of hadrons with free quarks and gluons). During the seven-year period, a technical project should be adopted and the creation of the first phase of the SPD experimental setup for research in the field of spin physics should be completed.

The main direction of JINR scientific research **in the field of modern nuclear physics** is the synthesis of new elements of the Periodic Table, the study of their properties by nuclear spectroscopy ( $\alpha$ -,  $\beta$ -,  $\gamma$ -spectroscopy), as well as their chemical properties, the study of the mechanisms of various nuclear reactions leading to the formation of new, yet unknown nuclei. The commissioning of a new accelerator complex, the Factory of Superheavy Elements (SHE), greatly expanded the capabilities of JINR in the field of synthesis and study of the properties of superheavy nuclei and atoms. Research, as well as the development of the necessary infrastructure to study the structure of light nuclei far from the line of stability will be continued.

**Nuclear reactions caused by neutrons** are a tool for studying fundamental symmetries at the nuclear level, as well as for studying the deep restructuring of nuclear systems, for example, in fission processes. Data on the nuclei structures obtained as a result of reactions with neutrons, the energy dependences of the cross sections for neutron reactions are still required or need to be further clarified. The study of cross sections for the interaction of neutrons with nuclei for the needs of nuclear power engineering is of vital importance. The most requested data are presented in the Nuclear Energy Agency's Nuclear Data High Priority Request List (HPRL), which is a compilation of the current highest priority nuclear data requirements.

**In the field of condensed matter physics**, the main task is to study the structure, magnetic ordering, dynamics, physical and chemical properties of promising functional materials, complex liquids and polymers, nanosystems, which are important for the development of both modern concepts in this scientific field and new technological applications in energy production, electronics, biology, medicine, etc. To this end, it is planned to continue the active development of experimental facilities for the most efficient use of all the capabilities of the IBR-2 pulsed reactor – one of the three most intense neutron sources in the world. Within the framework of the new Seven-Year Plan, work will be carried out to develop new fuel and load IBR-2 with it. The development of the NEPTUNE pulsed fast reactor, a new world-class facility for conducting research with neutron beams, will continue; work will continue on studying the oscillatory stability of the reactor and on developing a scientific research programme, as well as work on creating a fuel load for the reactor will begin. Also, within the framework of the current Seven-Year Plan, work will

begin on modeling the experimental infrastructure of the new source, including elements of experimental facilities with prototyping of individual components at IBR-2.

The presence of a wide range of radiation sources, and above all, beams of heavy ions of various energies at the JINR basic facilities, provides a unique opportunity to solve the fundamental problems of **modern radiobiology, astrobiology, neurophysiology, molecular biology and genetics**, as well as practical applications in radiation medicine and radiation risk assessments on Earth and in space. The planned radiobiological experiments at the nuclear physics facilities of the Institute will be aimed at studying the mechanisms of action of ionizing radiation with different physical characteristics at the molecular, cellular, tissue and organismal levels of biological organization. Particular attention will be paid to the development of new approaches to increasing the biological effectiveness of radiation for radiation therapy of tumors and to studies of the mechanisms of functional brain disorders under the action of radiation. Research in astrobiology is aimed at solving the problem of the origin of life in the Universe using nuclear physics methods.

The latest nuclear physics methods being developed at JINR provide great opportunities for unique studies of cultural heritage objects in the field of archeology, paleontology, ecology, and nuclear forensic sciences.

The concept of the development of information technologies, scientific computing and Data Science, in the JINR Seven-Year Plan, provides for the creation of a scientific IT ecosystem that combines many different technological solutions, trends and methods. The IT ecosystem implies the coordinated development of interconnected IT technologies and computational methods aimed at maximizing the number of JINR strategic tasks to be solved that require intensive data calculations. Particular attention will be paid not only to increasing the performance of the computing systems and resources of the MICC storage systems, including the “Govorun” supercomputer, but also to the further development of the JINR network infrastructure. The most important tasks are the development of new data processing and analysis algorithms based on deep and machine learning, including artificial intelligence, and the development of modern Big Data methods and algorithms for solving applied problems. Research in the field of quantum computing will be aimed at developing algorithms for the intelligent control of JINR physical experimental facilities and at optimizing the solution of resource-intensive problems. The development of the digital platform “JINR Digital Ecosystem”, which integrates existing and future services to support scientific, administrative and social activities, as well as the maintenance of the engineering and IT infrastructures of the Institute, will provide reliable and secure access to various types of data and will enable a comprehensive analysis of information using modern Big Data technologies and artificial intelligence.



## DEVELOPMENT OF A LARGE JINR RESEARCH INFRASTRUCTURE

The main goal of the NICA project is the development and operation of the accelerator complex, which makes it possible to carry out studies with colliding beams of high-intensity ions (up to  $\text{Au}^{+79}$ ) with an average luminosity  $L = 10^{27} \text{ cm}^{-2} \text{ s}^{-1}$  in the energy range  $\sqrt{s_{NN}} = 4\text{--}11 \text{ GeV}$ , with beams of polarized protons ( $\sqrt{s_{NN}}$  up to 26 GeV) and deuterons ( $\sqrt{s_{NN}}$  up to 12 GeV) with longitudinal and transverse polarization, as well as with extracted beams of ions and polarized protons and deuterons.



**Fig. 2.** NICA Heavy Ion Accelerator Complex

To effectively use the capabilities of the NICA complex, the following experimental facilities will be put into operation: the BM@N facility for extracted beams and the MPD and SPD facilities for the collider.

The technological start-up of the complex and the registration of the first ion collisions on colliding beams by the MPD-I facility should take place in the middle of 2025. The following stages of commissioning and development of elements of the NICA complex are envisaged to be taken:

1. Commissioning of the basic elements of the NICA accelerator complex (basic configuration of the collider – 2024; development of the collider to the design configuration – 2025–2027; creation of experimental zones and channels of extracted beams – 2024).
2. Creation of ancillary user infrastructure around ARIADNA channels and irradiators, including areas for temporary deployment of users' own equipment. Launch and support of an international user program at the facilities for applied research of the NICA complex, including the development and opening of a special web portal for the program. Development of international collaborations in applied research at the NICA complex. Conducting R&D to further develop the ARIADNA research infrastructure – 2024-2030.
3. Completion of modernization and commissioning of the BM@N facility for experiments with high-intensity heavy-ion beams extracted from the Nuclotron – 2023-2026.
4. Physical research and development of the MPD facility, including the launch of the first stage of the facility at the end of 2024 and the full configuration in 2025-2026.
5. Creation and commissioning of the initial configuration of the SPD detector – 2028.

**Table 1.** Work schedule for the construction and operation of the NICA complex

	2022	2023	2024	2025	2026	2027	2028	2029	2030
<b>Collider commissioning</b>		<b>Commissioning runs</b>							
<b>MPD complete configuration construction and operation</b>			<b>System design and production</b>		<b>Detector extended mode operation</b>				
<b>Collider development to design configuration</b>									
<b>Preparation and start of polarized beam operation</b>		<b>SC-solenoids production and tests</b>			<b>Spin transparency mode operation</b>				
<b>SPD construction and commissioning</b>	<b>R&amp;D, prototyping, testing</b>			<b>SPD system production and assembly</b>		<b>SPD operation</b>			
<b>Nuclotron modernization</b>	<b>R&amp;D, prototyping, testing</b>			<b>Magnets production, ring assembly</b>		<b>New Nuclotron operation</b>			

**Table 2.** The NICA accelerator complex

(thousand US dollars)

	2024	2025	2026	2027	2028	2029	2030	Total
Material costs for development	36 000,0	31 700,0	32 000,0	29 300,0	29 200,0	28 900,0	24 200,0	211 300,0
Material costs for operation and maintenance	7 910,0	9 102,0	10 911,0	16 215,0	17 720,0	17 717,0	2 149,3	81 724,3
<b>Total</b>	<b>43 910,0</b>	<b>40 802,0</b>	<b>42 911,0</b>	<b>45 515,0</b>	<b>46 920,0</b>	<b>46 617,0</b>	<b>26 349,3</b>	<b>293 024,3</b>

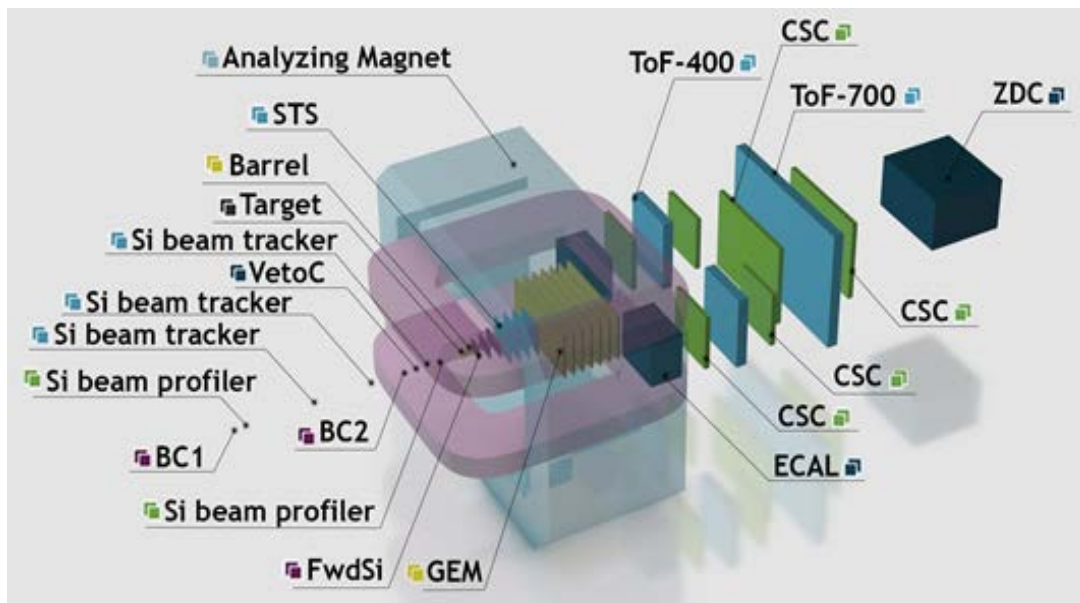

**Fig. 3.** Full configuration of BM@N detectors for implementation of research with heavy ion beams

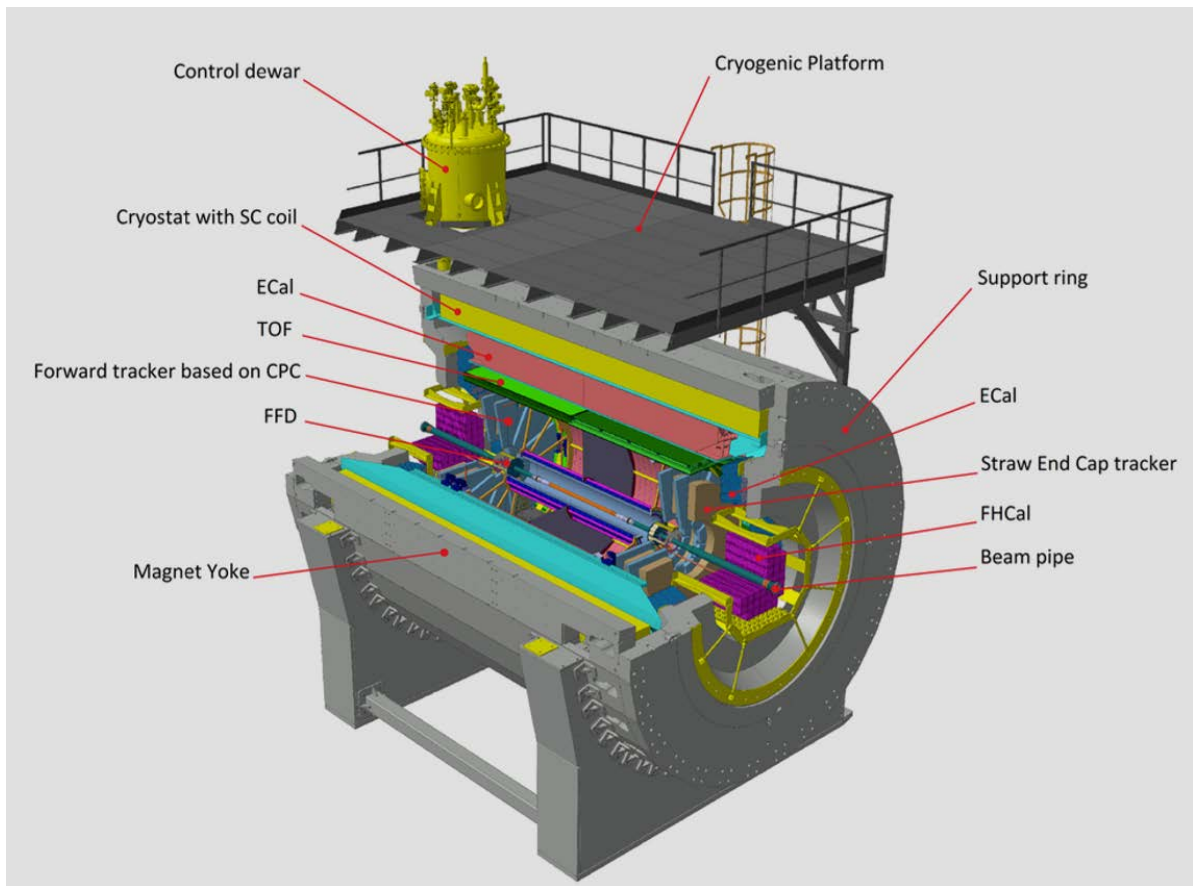

**Fig. 4.** General scheme of the Multi-Purpose Detector (MPD)

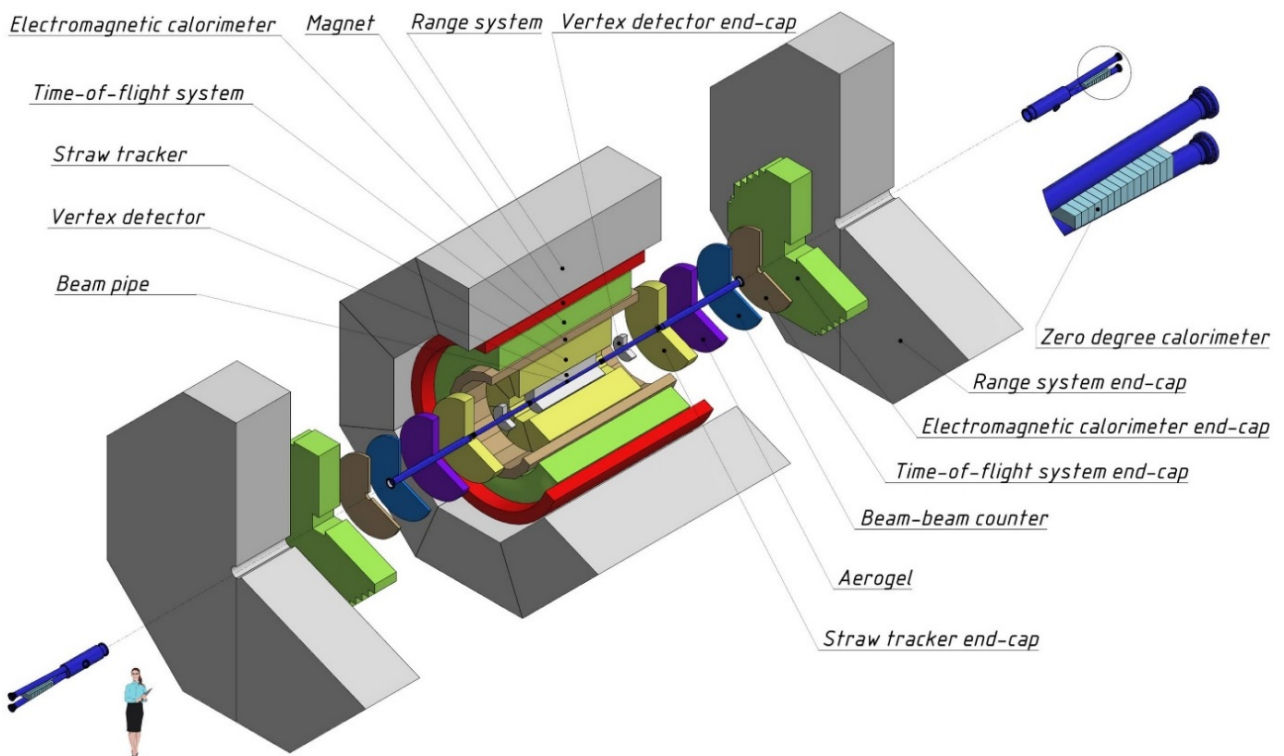

**Fig. 5.** General scheme of the Spin Physics Detector (SPD)

**The Factory of Superheavy Elements**, based on a specialized DC-280 cyclotron and equipped with new-generation experimental facilities, is the most important component of the **DRIBs-III (Dubna Radioactive Ion Beams)** project. The full-scale implementation of this project is a priority task for the Flerov Laboratory of Nuclear Reactions for the period 2024–2030, the phased solution of which will significantly expand the possibilities for conducting fundamental and applied nuclear physics research at JINR at the highest level in broad cooperation with scientific centres of the Member States of the Institute and other countries.

In the period 2024–2030, the following is planned:

1. Development of methods for obtaining intense beams of  $^{48}\text{Ca}$ ,  $^{50}\text{Ti}$ ,  $^{54}\text{Cr}$ , etc.
2. Creation of a new ECR-type ion source operating at a frequency of 28 GHz.
3. Development of a fleet of experimental facilities: launching a cryogenic gas trap, creating a super-resolution multi-reflective time-of-flight mass analyzer and a superconducting pre-separator based on a gas-filled solenoid, developing a chemical plant. It is also planned to design a Penning trap and develop laser spectroscopy methods.

**Reconstruction of the U-400 accelerator complex and creation of a new experimental hall.** Expanding the total area of the experimental hall to 1500 m<sup>2</sup> with the possibility of autonomous operation in radiation-isolated cabins is aimed at creating a new experimental building for the U-400R accelerator. The planned construction completion date is 2026. At the same time, the reconstruction of the cyclotron will be carried out, with a focus on:

- Expansion of the range of accelerated ions from helium to uranium;
- Reduction of the ion beam energy spread to 0.3% with a smooth energy variation in the range of 0.8–25 MeV·A;
- Reducing energy consumption and increasing the stability of work in long exposure sessions;
- Obtaining beams of rare isotopes of stable and long-lived nuclei, as well as short-lived nuclei ( $T_{1/2} \geq 0.1$  s) injected into an ion source or directly into a vertical external injection channel.

Along with the construction and reconstruction of the cyclotron, new experimental facilities will be created. In particular, it is planned to develop and create a separator for studying the dynamics of multinucleon transfer reactions, as well as for obtaining and studying the properties of nuclei formed in these reactions.

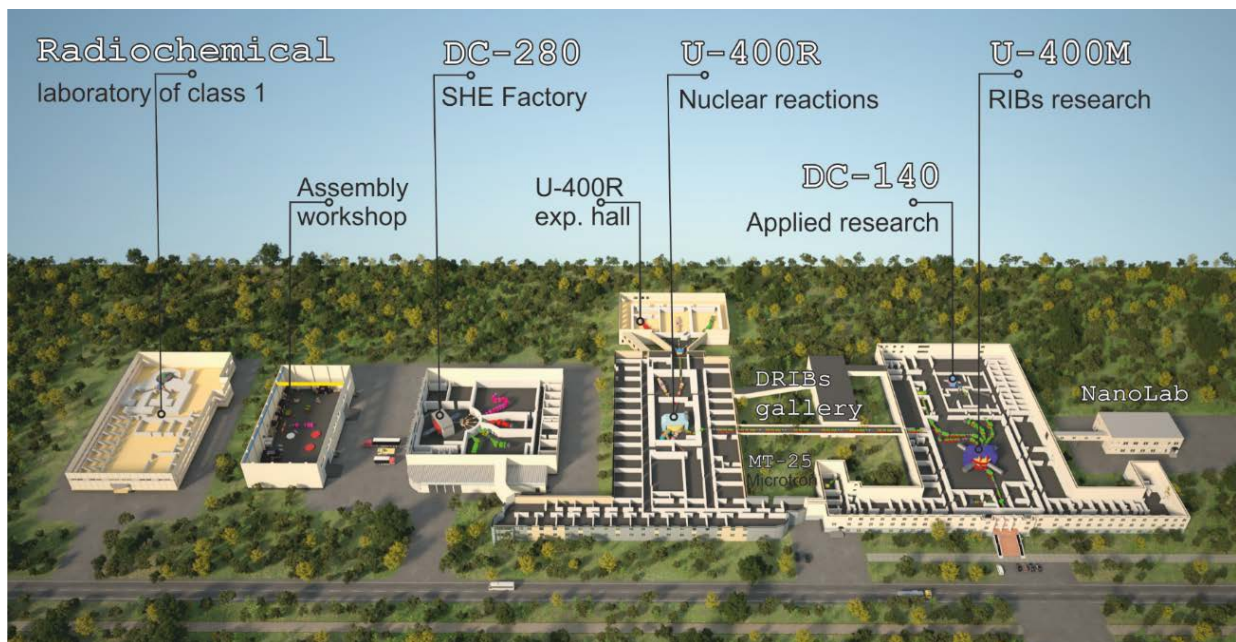

**Fig. 6.** Plan of the Laboratory of Nuclear Reactions, taking into account the infrastructure facilities planned for construction in 2024–2030

**Development of the DC-140 accelerator complex.** In 2024—2030, the creation and development of the DC-140 accelerator complex will be continued in terms of reaching the design parameters of beams, as well as equipment for experimental channels. The tasks of the complex are related to research in the field of solid state physics, surface modification of various materials, production of track membranes, as well as testing the radiation resistance of electronic components.

**Table 3.** The DRIBs-III cyclotron complex

	(thousand US dollars)							
	2024	2025	2026	2027	2028	2029	2030	Total
Material costs for development	18 656,7	17 082,4	10 320,6	9 462,6	9 908,9	13 059,8	13 615,8	92 106,8
Material costs for operation and maintenance	2 603,7	2 322,5	2 431,7	2 873,1	3 204,8	3 255,9	3 308,3	20 000,0
<b>Total</b>	<b>21 260,4</b>	<b>19 404,9</b>	<b>12 752,3</b>	<b>12 335,7</b>	<b>13 113,7</b>	<b>16 315,7</b>	<b>16 924,1</b>	<b>112 106,8</b>

**Creation of a radiochemical laboratory of the 1st class.** The laboratory will be equipped with a powerful electron accelerator and will allow working with highly active materials, including:

- Production and regeneration of targets for the SHE Factory;
- Development of new technologies for producing radioisotopes and extracting them from irradiated targets for scientific, radioecological and medical applications.

**The IBR-2 reactor** is the JINR basic facility for neutron research in the field of condensed matter physics, the only facility of this kind in the JINR Member States.

The IBR-2 Reactor Development Programme for 2024–2030 will include:

- development and operation of the complex of cryogenic moderators, development of control and monitoring systems for the complex of cryogenic moderators KZ-201, KZ-202, KZ-203 of the IBR-2 reactor;
- checking the assembly, adjustment and testing of the MR-3R reserve movable reflector at the FLNP test bench.
- renewal of technological equipment of the reactor with an expiring service life.

The IBR-2 spectrometers complex development programme is aimed at increasing the efficiency of using these instruments and bringing them up to the level of the world's best facilities. The main directions for 2024–2030 are the following:

- creation of a basic configuration of a new inelastic scattering inverse geometry spectrometer with an efficiency 200 times higher than the existing NERA spectrometer;
- creation of a prototype source of ultracold neutrons, demonstrating the possibility of using the peak power of the source to generate high-density UCNs;
- completion of work on the creation of a new small-angle/neutron diffraction facility;

**Table 4.** IBR-2 and its complex of spectrometers

	(thousand US dollars)							
	2024	2025	2026	2027	2028	2029	2030	Total
Material costs for development	3 100,0	3 962,0	3 644,0	3 400,0	3 442,0	3 494,0	3 484,0	24 526,0
Material costs for operation and maintenance	2 463,8	2 197,8	2 817,8	3 137,9	3 137,9	3 137,9	3 137,9	20 031,0
<b>Total</b>	<b>5 563,8</b>	<b>6 159,8</b>	<b>6 461,8</b>	<b>6 537,9</b>	<b>6 579,9</b>	<b>6 631,9</b>	<b>6 621,9</b>	<b>44 557,0</b>

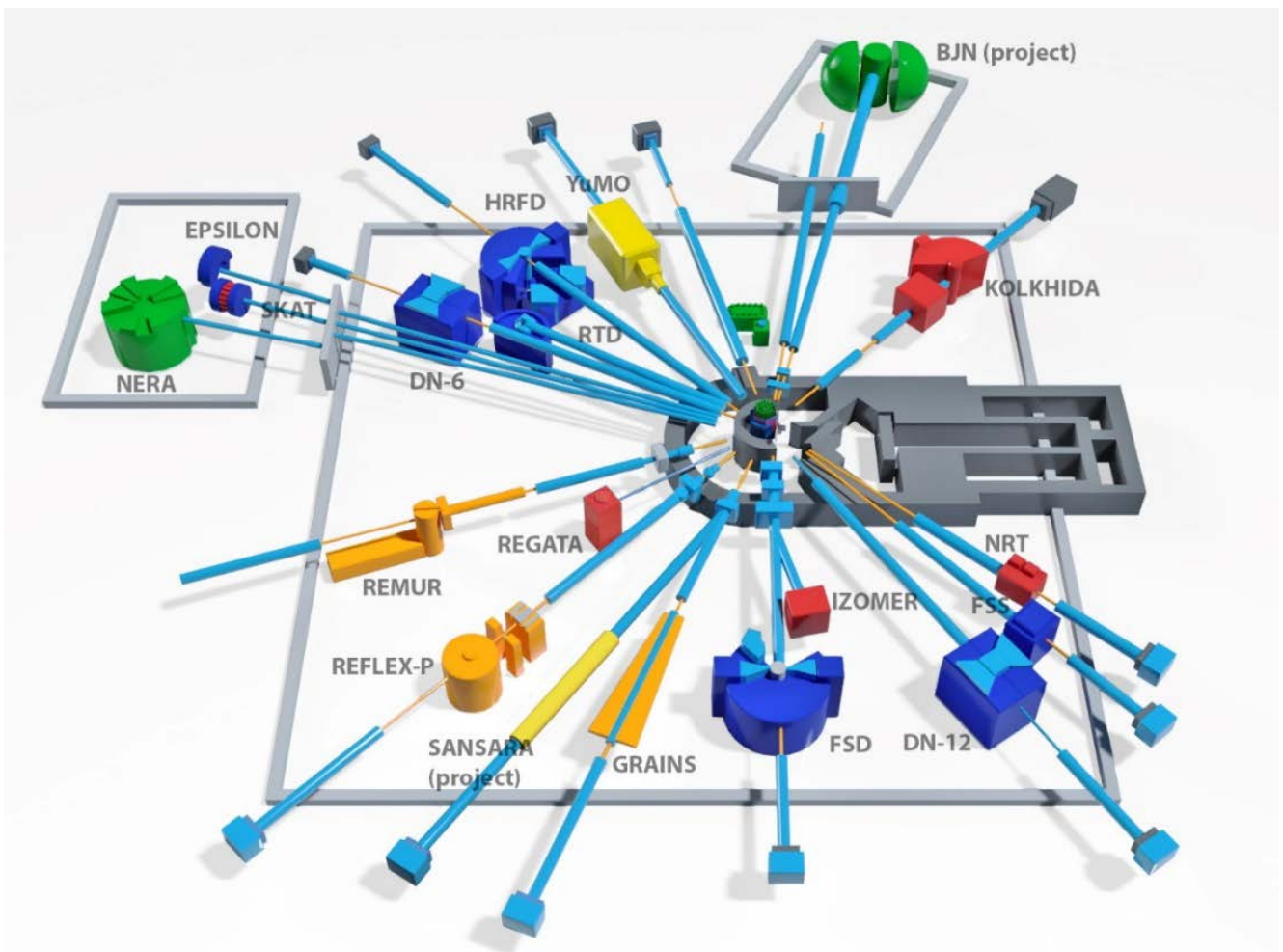

**Fig. 7.** IBR-2 spectrometer complex

- stage-by-stage modernization of the infrastructure of all instruments operating at IBR-2 construction of mirror neutron guides, creation of wide-aperture detectors, sample environment devices;
- creation of new large-area neutron detectors, introduction of multichannel high-speed electronics for data collection and analysis.

Work on **the creation of a new neutron source at JINR** will be carried out in the following areas:

1. Implementation of the R&D programme for the development of a new NEPTUNE reactor: *study of the dynamics of pulsed reactors*, optimization of the vessel of the new reactor and its reactivity modulator in terms of reducing thermal loads and shape change, development of neptunium nitride fuel and fuel elements based on

it, optimization of the configuration of the moderator complex, development of test benches.

2. Development of the scientific programme and the concept of the instrumental base for research in condensed matter physics and nuclear physics and for applied research at the new NEPTUNE reactor.

3. Development of draft and infrastructure (shape) designs of the new NEPTUNE reactor, justification of investments. Preparation and submission of a petition of intent to Rosatom State Corporation and the Government of the Moscow Region. The direction of justification of investments in the state structures of the Russian Federation, its approval.

4. Development of a feasibility study. Registration of an application for the inclusion of an object – the new NEPTUNE reactor – in the federal target programme.

5. Preparation for obtaining a license from Rostekhnadzor for the placement and construction of the new NEPTUNE reactor. Preparation of a technical specification for design. Development of a technical project.

6. Work on modeling the experimental infrastructure of a new source, including elements of experimental facilities with prototyping of individual components at the IBR-2 reactor.

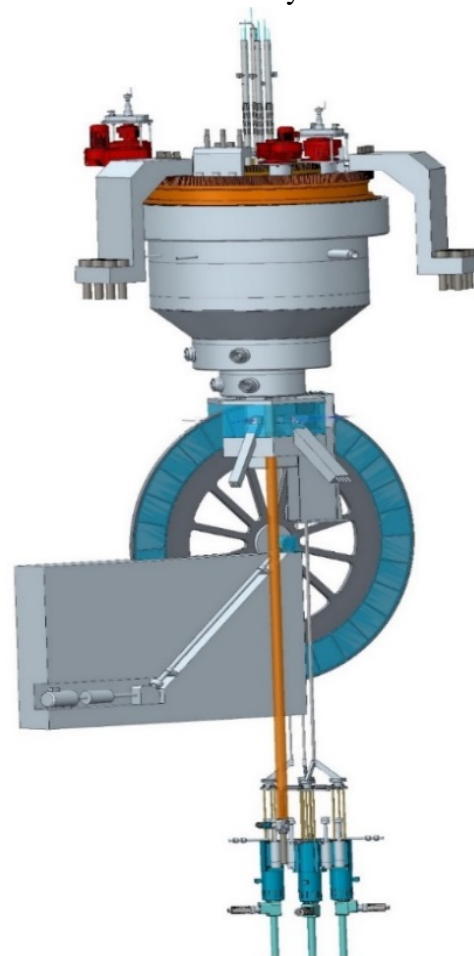
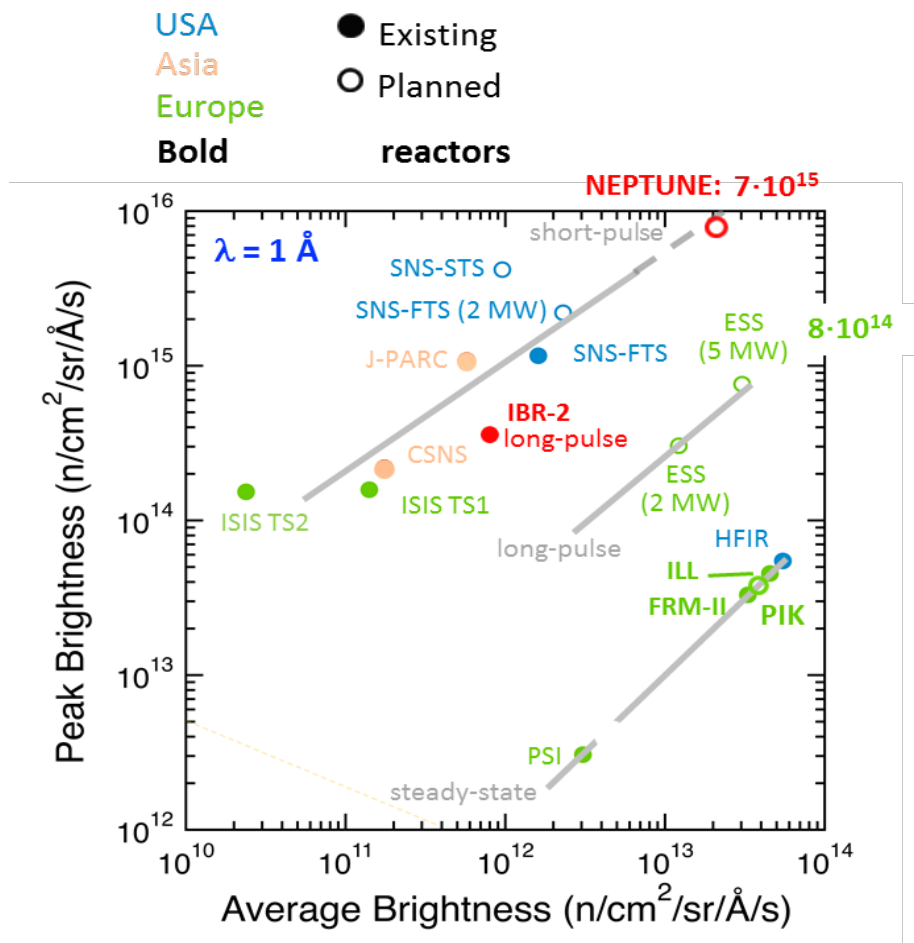

**Fig. 8.** A variant of the new NEPTUNE reactor

**Table 5.** New neutron source – the NEPTUNE reactor

(thousand US dollars)

	2024	2025	2026	2027	2028	2029	2030	Total
Material costs for development	2 298,0	3 887,0	4 032,0	2 457,0	2 312,0	2 457,0	2 557,0	20 000,0
<b>Total</b>	<b>2 298,0</b>	<b>3 887,0</b>	<b>4 032,0</b>	<b>2 457,0</b>	<b>2 312,0</b>	<b>2 457,0</b>	<b>2 557,0</b>	<b>20 000,0</b>



**Fig. 9.** Pulsed and average brightness for thermal neutrons of the IBR-2 reactor and the developed NEPTUNE source in comparison with neutron sources of various neutron centers

Within the next seven years, it is planned to increase the intensity of the neutron flux of **the IREN facility** up to  $3 \cdot 10^{12}$  n/s, as well as to increase the beam current of **the EG-5 accelerator** to 50  $\mu$ A, and its energy to 4.1 MeV.

It is planned to reach the accelerator operating mode of 3000 hours/year. In the long term, in order to implement promising research programmes with fast neutrons, JINR plans to build an intense source of fast neutrons on a tandem accelerator, which will make it possible to obtain quasi-monoenergetic neutrons in a wide energy range from 0 to  $\sim 20$  MeV. By the end of the seven-year period, it is planned to create a conceptual design for a new compact neutron source based on the accelerator, its infrastructure, research programme and practical applications.

### SOLCRYS Structural Research Laboratory

Condensed matter research at JINR is carried out in the field of studying new materials (catalysts, polymers, etc.), nanomaterials (nanoparticles, nanocomposites, etc.), materials under extreme conditions (superconductors, perovskites, etc.), and biomaterials (proteins, DNA, etc.). Research methods based on the scattering of synchrotron radiation will be developed on the basis of the National Synchrotron Radiation Centre SOLARIS of the Jagiellonian University in Krakow, where JINR is participating in the creation of a new Laboratory for Structural Research SOLCRYS. It is planned to create three measuring stations:



- for macromolecular X-ray crystallography (equipped with a high-precision goniometer for measuring the crystallographic structure of proteins);
- for small-angle X-ray scattering on bio-samples (beam  $\sim 11 \times 13 \mu\text{m}^2$ , flux  $\sim 8.6 \cdot 10^{11}$  ph/s; resolution  $\sim 70$  eV);
- for powder diffraction under extreme conditions (beam  $\sim 31 \times 15 \mu\text{m}^2$ , flux  $\sim 4.1 \cdot 10^{12}$  ph/s; resolution  $\sim 70.8$  eV).

**The SOLCRYS Laboratory construction programme includes:**

- extension of the existing experimental hall to accommodate the end stations of the crystallographic line, as well as a laboratory for sample preparation;
- development of the technical infrastructure to the extent necessary for the installation and proper operation of the research equipment of the SOLCRYS Laboratory.

**The Gigaton Volume Neutrino Telescope (Baikal-GVD) in Lake Baikal is the result of research and field tests carried out by the Baikal Collaboration in the first phase of this project over the past few years. During this time, the optical properties of water at the depths of Lake Baikal were studied and the fundamental possibility of detecting high-energy cosmic neutrinos using the NT200/NT200+ detector prototype was demonstrated. These achievements made it possible to prove the correctness of the concept underlying the creation of the new Baikal-GVD facility, which will have unique detecting characteristics and an effective working volume on the scale of a cubic kilometer.**

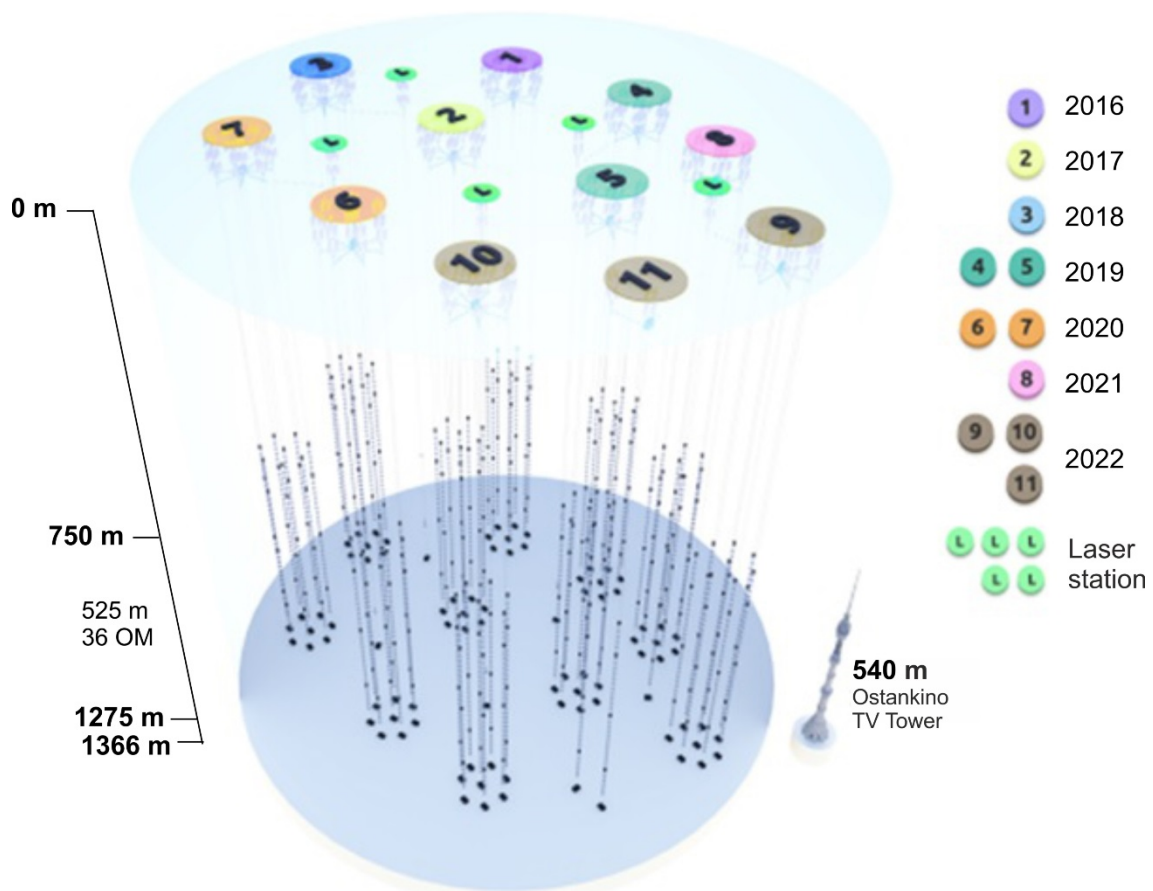

**Fig. 10.** Telescope deployment status as of late 2022. The setup contains 2916 optical modules and seven laser calibration light sources at five stations

Within the framework of the Seven-Year for 2017–2023, 12 clusters of the Baikal-GVD facility were put into operation, and by 2025, the first stage of the creation (deployment) of the entire detector with an effective working volume of more than 0.5 km<sup>3</sup> will be completed.

In the second phase of its development (within the seven-year period of 2024-2030), the Baikal-GVD neutrino telescope will be a new research infrastructure aimed primarily at studying astrophysical neutrino fluxes. The detector will use Baikal water as a detecting substance, in which optical sensors are placed that register the Cherenkov radiation from secondary particles resulting from interactions of high-energy neutrinos inside the working volume of the detector or in close proximity to it. The concept of the Baikal-GVD facility is based on a number of fairly obvious requirements for the design and architecture of a system for collecting information from a distributed array of detecting clusters. These are the utmost use of the advantages of array deployment on the ice cover of the Lake, the extendibility of the facility and provision of its constant effective operation, as well as the possibility of various versions of arrangement of light sensors within one measuring system.

In the coming years, a new strategy for the development of the large-scale Baikal-GVD research complex will be intensively considered.

The second phase of the Baikal-GVD neutrino telescope, the implementation of this new strategy, will begin at the turn of 2025 and is scheduled for completion in 2030, when the facility will have more than 20 clusters (approximately 6000-7000 optical modules) with an effective working volume of about or above one cubic kilometer.

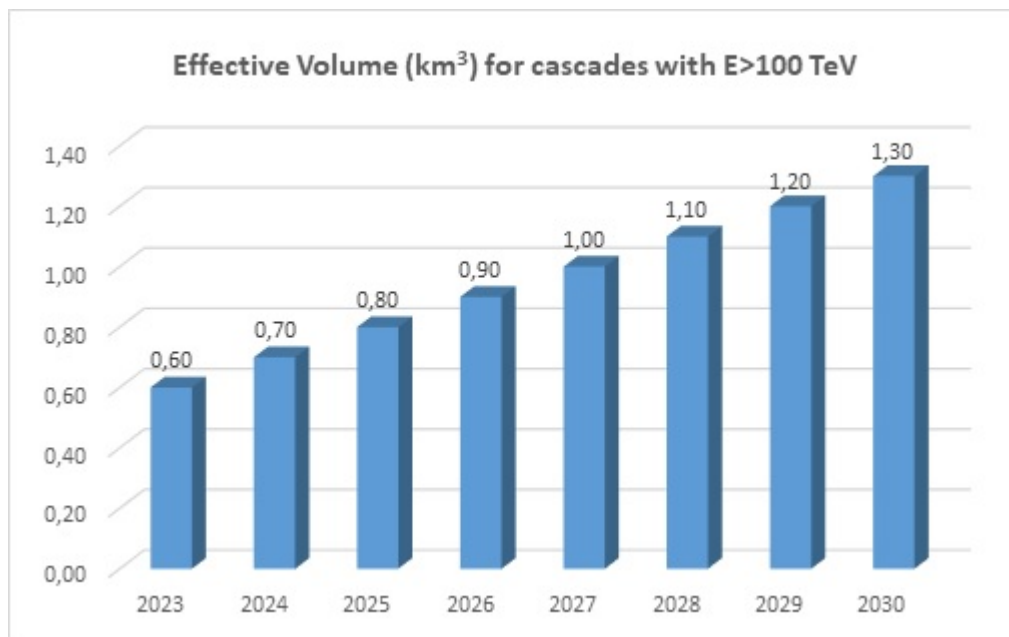

**Fig. 11.** The Baikal-GVD experiment. Detector expansion plan in terms of effective volume in the problem of astrophysical flow detection

The speed of gathering statistics will be close to that of IceCube. This will allow us to study and, in a certain sense, control the entire outer space at the same statistical level. Given the advantages of the Northern Hemisphere for observing the center of our Galaxy, it is expected that this will allow the Baikal-GVD telescope to outpace IceCube in obtaining critical information about what is happening in this center. In fact, this means that Baikal-GVD will become not only a full-fledged, but also the most important link in the Global Neutrino Network.

At present, the KM3NeT European project has been activated in the Northern Hemisphere, which is aimed at creating in the near future a distributed installation in the Mediterranean Sea, comparable to Baikal-GVD in terms of working volume. To ensure the leadership of Baikal-GVD, special measures must be taken.

A detector volume of 1 km<sup>3</sup> means a significant increase in the number of clusters, and their large number opens up the possibility of a systematic study of multicluster neutrino events, in particular, events caused by ultrahigh-energy  $\tau$  neutrinos, since the topology of such events is characterized by a noticeable increase in the width of the expansion cone of products of interaction of  $\tau$  neutrinos with nuclei.



**Fig. 12.** Assembling the Baikal-GVD installation cluster garland

**Table 6.** The Baikal-GVD Neutrino Telescope

(thousand US dollars)

	2024	2025	2026	2027	2028	2029	2030	Total
Material costs for development	5 000,0	5 000,0	4 000,0	4 000,0	4 000,0	4 000,0	4 000,0	30 000,0
Material costs for operation and maintenance	800,0	800,0	800,0	800,0	800,0	800,0	800,0	5 600,0
<b>Total</b>	<b>5 800,0</b>	<b>5 800,0</b>	<b>4 800,0</b>	<b>4 800,0</b>	<b>4 800,0</b>	<b>4 800,0</b>	<b>4 800,0</b>	<b>35 600,0</b>

### Multifunctional Information and Computing Complex

To achieve the main goals of the key JINR projects, a huge amount of experimental data will have to be processed. Very roughly, these are tens of thousands of processor cores. In particular, the NICA project requires grid infrastructures of Tier0, Tier1, and Tier2 levels, and the neutrino program needs computational

and storage resources. To maintain leading research at JINR, it is necessary to develop distributed multilevel heterogeneous computing environments, including those on the resources of the participants of the experiments.

The Tier0 and Tier1 centers for the NICA project are assumed to be created on JINR resources, including hundreds of petabytes of long-term raw data storage. This will allow for 25–30% of all computing resources in the distributed system, provision and support of the main services for the distributed computing system (DIRAC, PanDA, etc.).

The data storage and computing capacity of the WLCG project, aimed at solving the tasks in the scope of JINR participation in the CERN experiments, should increase annually by 10–20%, thus maintaining the required processing speed.

The elaboration of new deep and machine learning algorithms for data processing and analysis will require the support and development of a high-performance computing infrastructure. The “Govorun” supercomputer is a flexible, scalable, hyper-converged system that combines computational architectures of different types, a hierarchical data processing and storage system. The development of the “Govorun” supercomputer is aimed at creating an environment for supercomputer modeling and solution of resource-intensive theoretical and experimental tasks of JINR. Such a research environment is required for parallel computing, ML/DL/AI tasks, quantum computing, data analysis and visualization tools, application packages, web services for applications, training courses and practices.

One of the main priorities of the Seven-Year Plan is to expand the JINR cloud infrastructure and create an integrated cloud environment for experiments performed at JINR and its Member States based on containerization technologies. Progress in this field will depend mainly on the readiness of the experiments to adopt such a workflow.

The development of information technologies directly affects the further development of the JINR network infrastructure. The support of modern network technologies includes software-defined networking (SDN), content delivery networks (CDN), named data networking (NDN), and the technology for building distributed data procession centers (Data Center Interconnect, DCI).

The Big Data development strategy at the Institute includes a wide range of research: preparation of the infrastructure for Big Data storage and processing (hardware and software, security); elaboration of modern methods and algorithms of Big Data for solving applied tasks; intelligent monitoring of the operation and security of distributed computing systems; providing the Big Data infrastructure to users.

The first-priority task in the field of the development and application of quantum computing, quantum software engineering and quantum intelligent control is the creation of quantum systems of intelligent control of physical experimental facilities, including those for unpredictable situations.

Based on these requirements, the main direction of the development of the MLIT IT ecosystem is connected with the update of network communication channels, the engineering and computing infrastructure of the Multifunctional Information and Computing Complex (MICC) as well as the development of data processing and storage technologies for the NICA experiments and the JINR neutrino program. To ensure a sustainable operation of the MICC, the existing infrastructure needs to be regularly upgraded and maintained.

The IT ecosystem will become a platform for training IT specialists engaged in developing algorithmic and software solutions for JINR tasks.

The work will be carried out in close cooperation with research teams and IT specialists from all JINR Laboratories and the Member States.

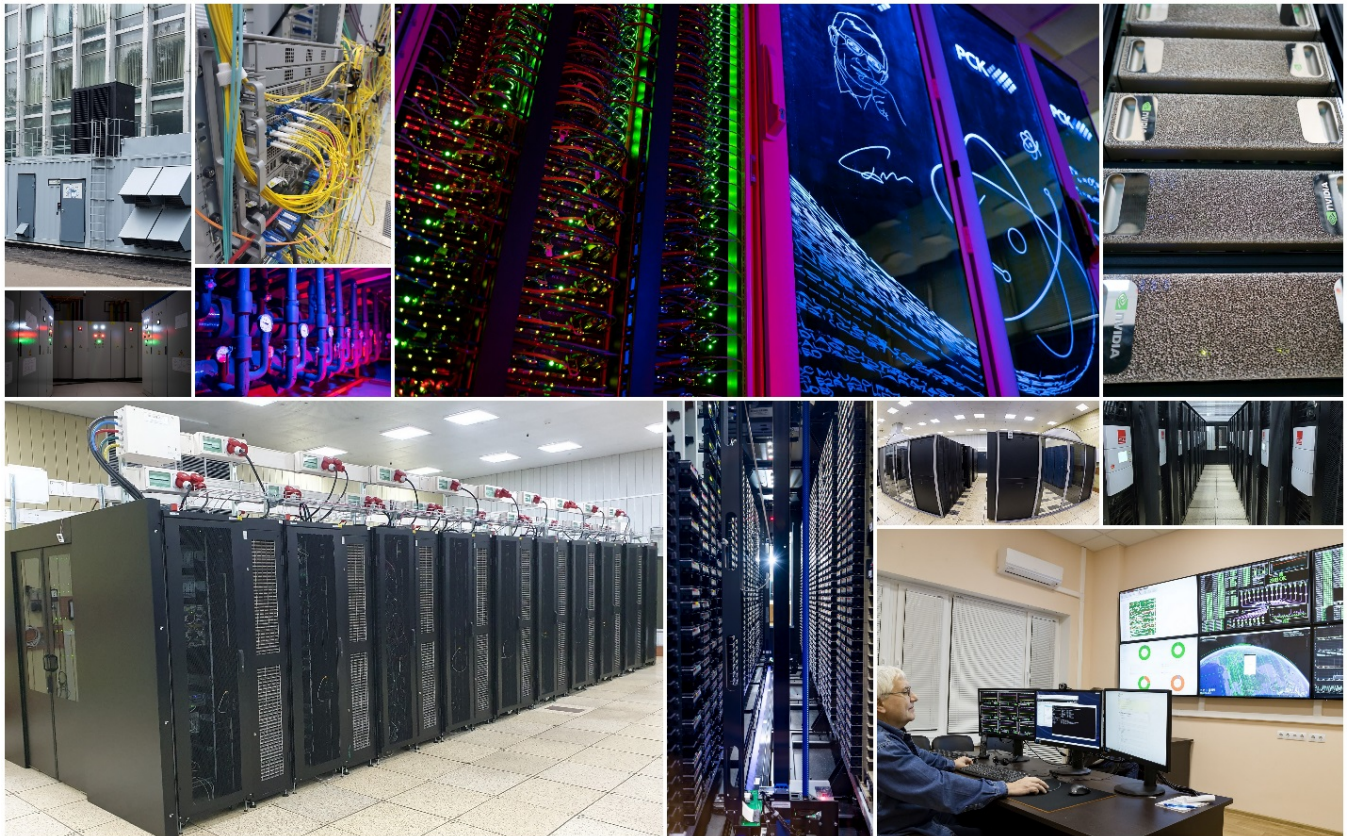

**Fig. 13.** Elements of the Multifunctional Information and Computing Complex

**Expected results:**

1. Modernization of the engineering infrastructure of the MICC JINR (reconstruction in accordance with modern requirements of the engine room of the 4th floor of MLIT).
2. Modernization and development of the offline distributed computing platform for the NICA project with the involvement of NICA Collaboration computing centers.
3. Creation of a Tier0 grid cluster for the NICA megaproject experiments to store experimental and simulated data. Expansion of the performance and storage capacity of the Tier1 grid cluster and Tier2/CICC integrated storage systems as data centers for the NICA megaproject experiments, the JINR neutrino program and experiments at the LHC.
4. Expansion of the JINR cloud infrastructure to increase the range of services available to users applying containerization technologies. Automation of the deployment of cloud technologies in the organizations of the JINR Member States.
5. Expansion of the heterogeneous HybriLIT platform, including the “Govorun” supercomputer as a hyper-converged software defined environment with a hierarchical data storage and processing system.

6. Creation of a multipurpose software and hardware platform of Big Data analytics based on hybrid hardware accelerators (GPU, FPGA, quantum systems); machine learning algorithms; analytics, reporting and visualization tools; support for user interfaces and tasks.
7. Creation and development of a distributed software defined high-performance computing platform combining supercomputer (heterogeneous), grid and cloud technologies for the efficient use of new computing architectures.
8. Development of a computing infrastructure protection system based on fundamentally new paradigms, including quantum cryptography, neurocognitive principles of data organization and interaction of data objects, global integration of information systems, universal access to applications, new Internet protocols, virtualization, social networks, data of mobile devices and geolocation.

**Table 7.** Approximate estimate of required computing resources

		2024	2025	2026	2027	2028	2029	2030
LHC Tier1 (CMS)	CPU (Pflops)	1,53	1,69	1,84	2,03	2,22	2,45	2,68
	Disk (PB)	18	20	25	28	31	34	40
	Tape (PB)	46	50	60	70	80	90	100
	Network (Gbps)	200	400	400	600	600	800	800
LHC Tier2 (ATLAS, CMS, ALICE, LHCb) + etc.	CPU (Pflops)	0,73	0,81	0,88	0,96	1,04	1,15	1,27
	Disk (PB)	7,7	8,5	9,2	10	11,	12,80	14
	Network (Gbps)	200	400	400	600	600	800	800
“Govorun” supercomputer	CPU (Pflops)	1,2	2,2	3,2	4,2	5,2	6,2	7,2
	Disk (PB)	8	9	10	11	12	13	14
DataLake	Disk (PB)	60	60	60	80	80	80	100
*NICA Tier 0,1,2	CPU (Pflops)	2,2	2,6	8,6	8,6	15,6	15,6	15,6
	Disk (PB)	17	24	47	75	96	119	142
	Tape (PB)	45	88	170	226	352	444	536
	Network (Gbps)	400	400	400	400	400	400	400
*Baikal-GVD, NOvA, JUNO, DUNE Tier 0,1,2	CPU (Pflops)	0,94	1,02	1,2	1,28	1,36	1,54	1,62
	Disk (PB)	1,9	3,2	3,5	3,8	4,6	4,9	5,2
	Tape (PB)	9	12	15	18	21	24	27
	Network (Gbps)	200	200	200	200	200	200	200

\* The financing of computing resources for computing under the NICA project and the JINR neutrino program is carried out within the budgets of the corresponding directions.

**Table 8.** MICC

(thousand US dollars)

	2024	2025	2026	2027	2028	2029	2030	Total
Material costs for development	5 200,0	5 341,5	5 432,5	5 568,3	5 707,5	5 850,2	6 900,0	40 000,0
Material costs for operation and maintenance	1 933,6	1 986,2	2 064,1	2 145,4	2 235,9	2 331,5	2 439,0	15 135,7
<b>Total</b>	<b>7 133,6</b>	<b>7 327,7</b>	<b>7 496,6</b>	<b>7 713,7</b>	<b>7 943,4</b>	<b>8 181,7</b>	<b>9 339,0</b>	<b>55 135,7</b>

# ELEMENTARY PARTICLE PHYSICS AND HIGH-ENERGY HEAVY-ION PHYSICS

Scientific research in the field of elementary particle physics and high-energy heavy-ion physics can be divided into four interrelated directions – the energy-increasing accelerator direction (the Energy Frontier), the intensity-increasing accelerator direction (the Intensity Frontier), the accuracy-increasing non-accelerator direction (the Accuracy Frontier), and the particle astrophysics direction (the Cosmic Frontier). In view of these general directions, within the framework of the new Seven-Year Plan, JINR will focus on the following main topics:

1. Research in the field of particle physics, including particle spectroscopy, spin physics, neutrino physics and rare phenomena studies (covering the Energy, Intensity, Accuracy, and Cosmic Frontiers), aimed at extending the Standard Model and discovering new fundamental laws of Nature.
2. Research in the field of high-energy heavy-ion physics (Energy and Intensity Frontiers), aimed at establishing the unique properties of hadronic matter under conditions of phase transitions between the quark and hadronic states of matter.
3. Development of new-generation detector systems and accelerator complexes, theoretical support for current and planned experimental research, development and maintenance of high-performance telecommunication links and computing facilities at JINR, aimed at providing a comprehensive support for realization of the scientific tasks envisioned for by the Seven-Year Plan.

In the field of particle physics and high-energy heavy-ion physics, the new Seven-Year Plan will be implemented by efforts of four JINR Laboratories (VBLHEP, DLNP, MLIT, and BLTP) both on the basis of JINR's own facilities – the NICA accelerator complex and the Multifunctional Information and Computing Complex (MICC), and within the framework of international partner programmes at the world's largest accelerator facilities in the experiments with essential contribution made by JINR staff.

Taking into account the great scientific attractiveness of the ILC project, with a favorable situation with the filling of the Institute's budget, JINR intends to continue participating in the development of the accelerator and detector subsystems within the framework of this international project. The decision to continue the work will be made additionally at the stage of annual planning.

Within the framework of the FLASH and XFEL international projects, JINR physicists participate in the development of diagnostic systems of ultrashort bunches in a linear accelerator, X-rays, and large cryogenic systems.

**The study of hot and dense baryonic matter and its phase transformations** will be performed on the basis of the NICA complex. Experiments will be carried out with extracted beams of the Nuclotron at the BM@N setup and in the collider mode at MPD in heavy-ion collisions at the energy range  $\sqrt{s_{NN}} = 4\text{--}11$  GeV. The operation of the NICA complex and the mentioned detectors, their final adjusting to the design parameters, and obtaining new experimental results will be the primary tasks for VBLHEP. At the end of the seven-year period, the commissioning of the first stage of SPD for working with polarized collider beams is planned.

Groups of VBLHEP scientists will continue taking part in the study of the properties of nuclear matter under extreme conditions, in the search for quark deconfinement and possible phase transitions within the

framework of common research programmes in the STAR experiment at RHIC, BNL, in the NA61 experiment at the SPS accelerator (CERN), in the ALICE experiment at LHC (CERN). The scope of JINR's participation will depend on the progress in implementing the NICA project, as well as on the need to consolidate work at the JINR accelerator complex.

### Expected results:

1. Obtaining physical results at BM@N using high-intensity heavy-ion beams, including bismuth and gold ions, at different ion energies in the range (1.5 – 3.8) A GeV. Study of elliptic and direct flows, processes with the birth of hyperons with  $S = 2$  and hypernuclei. Investigation of the parameters of the equation of state of nuclear matter at high densities — 2025–2030.

2. Obtaining physical results at MPD in the research programme on the study of the properties of hot and dense baryonic matter in the central rapidity range, the search for phase transitions (observables – particle yields and their spectra), including partial restoration of chiral symmetry (observables – yields of dileptons), and the search for the critical end-point (observables – event-by-event fluctuations, particle correlations) — 2024–2030.

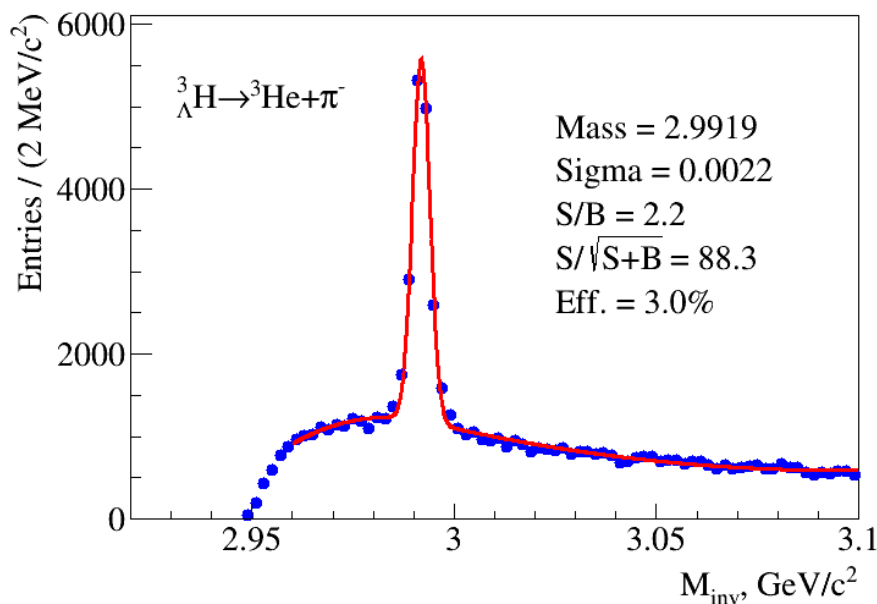

**Fig. 14.** To evaluate the prospects for studying hypernuclei at NICA, a detailed simulation of the MPD detector parameters was performed for the reconstruction of hypertritons in Bi+Bi collisions at a centre-of-mass energy of 9.2 A GeV. The distribution of the reconstructed invariant mass of the hypertriton in two-body decay mode is shown for the statistics of 40 million Bi+Bi collisions

3. Commissioning of the MPD Stage II. Beginning of the research programme with the MPD detector in the entire available phase space region — 2026–2030.

4. Study of the physics of strongly interacting matter, including the search for a critical point, the study of deconfinement, collective flows and the formation of an open charm in the NA61 experiment at SPS (CERN) – 2024–2030.

5. Obtaining new results in the Energy Scan Programme (3 – 200 GeV) in the STAR experiment (RHIC) – 2024–2025.

6. Obtaining new results on the study of physical phenomena in ultra-peripheral nucleus–nucleus collisions and in the femtoscopy programme in the ALICE experiment (LHC), participation in the upgrade of the photon detector of the ALICE facility — 2014–2030.



**The study of the nucleon spin structure and other polarization phenomena in nucleon–nucleon and nucleon–nucleus interactions, as well as in few-nucleon systems,** will be carried out at the VBLHEP accelerator complex, at CERN and BNL. Experiments will be performed at VBLHEP both with a fixed target and polarized beams of the Nuclotron and at the NICA collider, on the SPD detector. The implementation of the SPD physics programme is planned to start in 2028 after the construction of the first stage of the SPD detector is completed and the facility is put into operation. The SPD research programme will extend the ongoing research programmes of the COMPASS++/AMBER experiment (at SPS, CERN) on hadron structure and spectroscopy investigations with high-intensity muon and hadron beams, as well as with polarized proton beams at the STAR facility (RHIC), in which teams of VBLHEP and DLNP scientists of JINR will continue to take part during 2024–2028. The nature of JINR's participation in these programmes will be coordinated with the growing concentration of JINR's efforts on the creation of the SPD detector and its research programme.

#### **Expected results:**

1. Stage-by-stage commissioning of the infrastructure for controlling polarized beams, necessary to support experimental research of polarization phenomena within the framework of an international collaboration, – 2024–2027.
2. Carrying out the research programmes of the DSS and ALPOM-2 experiments with Nuclotron polarized beams. Approval and realization of new experiments developed to study nucleon spin structure and other polarization phenomena (both in nucleon–nucleon and nucleon–nucleus interactions and in few-nucleon systems) with Nuclotron beams, — 2024– 2030.
3. Putting of the SPD start-up configuration into operation at the NICA collider — 2028.
4. Obtaining new results on nucleon spin structure in the STAR experiment (RHIC) in the interactions of protons with protons and nuclei — 2024–2028.

#### **The search for physical phenomena beyond the Standard Model will be continued in the CMS and ATLAS experiments at CERN's LHC.**

JINR will take part in the second phase of detectors' upgrade during the LHC shutdown periods in 2026–2028 and will continue analysis of data from the LHC.

The JINR group will continue to participate in the NA64 experiment to search for weakly interacting particles of dark matter at the SPS accelerator at CERN. JINR will also take part in a search for charged lepton flavor violation in muon-to-electron conversion in nuclei in the  $\mu 2e$  (FNAL) and COMET (J-PARC) experiments.

JINR will continue to participate in the NA62 experiment to finalize precision measurement of the decay of a kaon into a pion and two neutrinos, as well as to perform a series of other measurements of very rare kaon decays at the particle physics Intensity Frontier, which will provide a decisive test of the Standard Model and the competitive search for dark matter candidates.

#### **Expected results:**

- obtaining new experimental results within the framework of the programme aimed at verification of the Standard Model (SM) predictions and a search for physics beyond the SM at CMS and ATLAS, fulfillment of obligations for the modernization of detectors – 2024–2028;
- experimental verification of theoretical models aimed at searching for dark matter particles using SPS beams – 2024–2030.

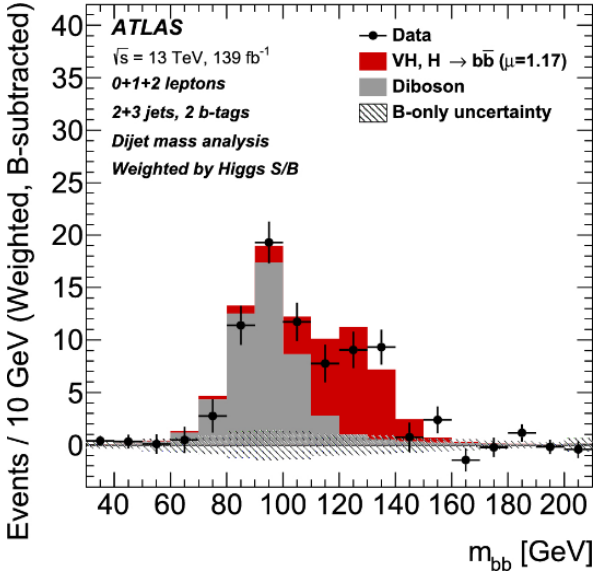

**Fig. 15.** The invariant mass distribution of a pair of b-jets obtained in pp collisions at an energy of 13 TeV in the ATLAS experiment in the processes of associated production of the Higgs boson with W and Z bosons and its decay into a pair of b-quarks. The contribution from all background processes is subtracted, with the exception of WZ and ZZ

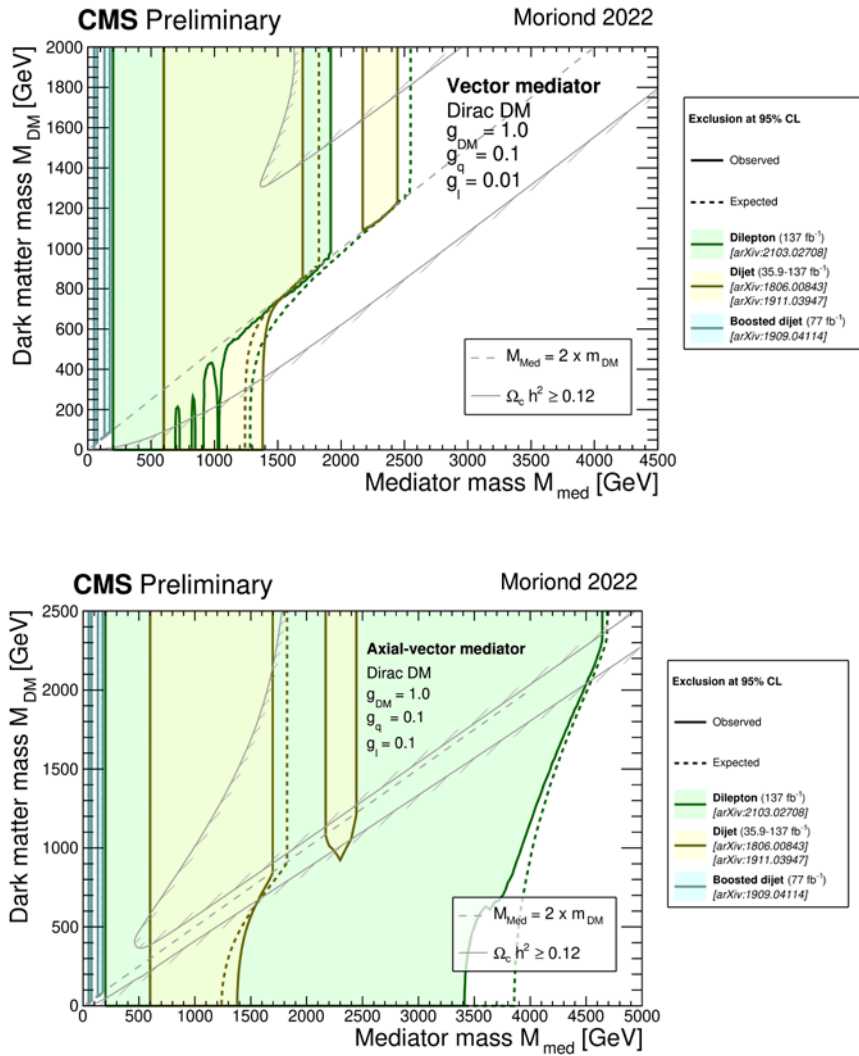

**Fig. 16.** In the combined channel of the production of a pair of jets and a pair of leptons in the events obtained in the CMS experiment at the LHC, the limits (95% C.L.) were determined on the masses of particle candidates for the role of dark matter particle  $m_{DM}$  and the mediator  $M_{med}$ . The shaded area corresponds to the excluded mass values for the vector (top) and pseudo-vector (bottom) mediator

**Neutrino physics and astrophysics** are among the most promising areas of research of the fundamental issues of modern elementary particle physics.

At present, neutrino physics has entered a new era of precision measurements, and the first main task in this direction today is **to determine the neutrino mass hierarchy and study the magnitude of CP violation in the lepton sector**. At the Dzheltopov Laboratory of Nuclear Problems of JINR, the neutrino mass hierarchy problem is being solved with the help of two complementary techniques using reactor and accelerator neutrinos in the JUNO and NOvA+T2K experiments, respectively.

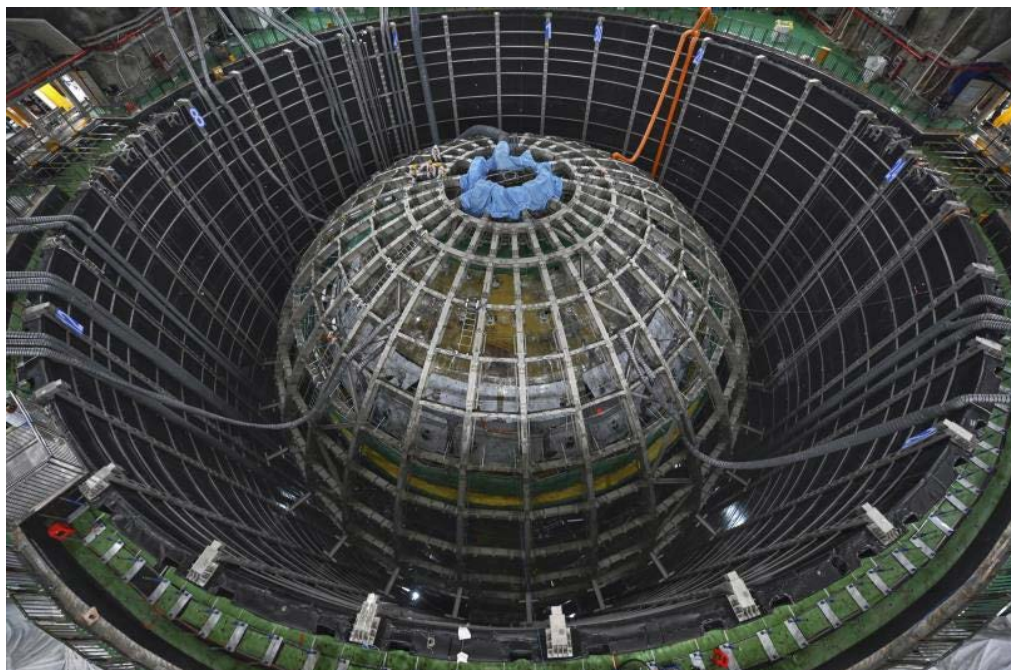

**Fig. 17.** Current status of the JUNO detector assembly

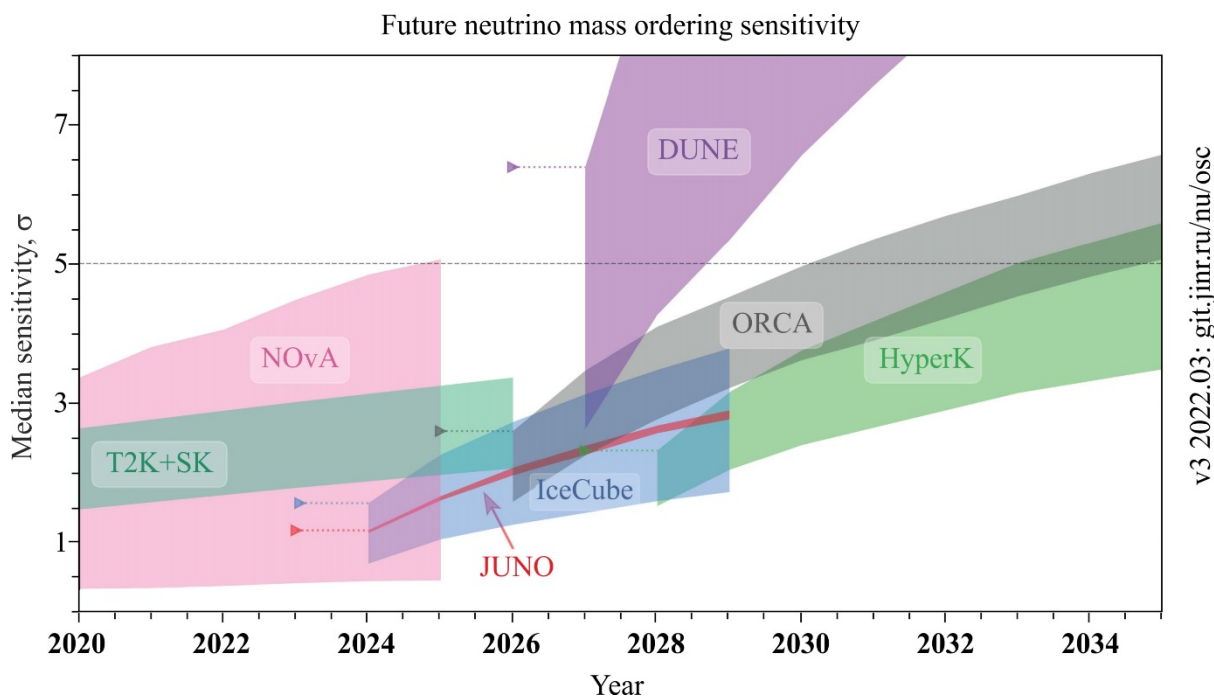

**Fig. 18.** Neutrino mass ordering sensitivity in current and planned experiments. The bands represent the entire range of possible measurements depending on other parameters

The study of CP violation in the lepton sector will be carried out with the help of another accelerator experiment – DUNE, in the preparation of which DLNP is taking an active part. JINR specialists from two Laboratories, DLNP and VBLHEP, conduct research and development of the DUNE Near Detector systems, in particular, for detecting light in liquid argon, and a tube-based tracking detector, based on the unique experience of JINR gained in these areas.

The second main task of modern neutrino physics is to **determine the absolute scale of the mass and nature of neutrinos, as well as their electromagnetic properties.** These problems are addressed at DLNP by studying the processes of double neutrinoless beta decay of nuclei within the framework of the GERDA-LEGEND and SuperNEMO projects, as well as in DLNP precision experiments at the Kalinin and Voronezh nuclear power plants. DLNP of JINR plays a leading role in advanced reactor neutrino experiments carried out in close proximity to nuclear reactors (DANSS, GEMMA/vGeN). The development of experimental techniques, synergy with other JINR low-background projects allow new research to be carried out at the forefront of science. The results of the research will be the search for neutrino oscillations into sterile states on a short baseline with the best sensitivity in the world; search for the neutrino magnetic moment at a level better than  $9 \cdot 10^{-12} \mu_B$ ; detection and study of coherent neutrino-nucleus scattering (CEvNS) in the zone of complete coherence; use of CEvNS for precision study of the electroweak sector, and search for New Physics beyond the Standard Model. An important application of fundamental research on reactor antineutrinos will be the development of a method for monitoring in-reactor processes using compact (anti)neutrino detectors.

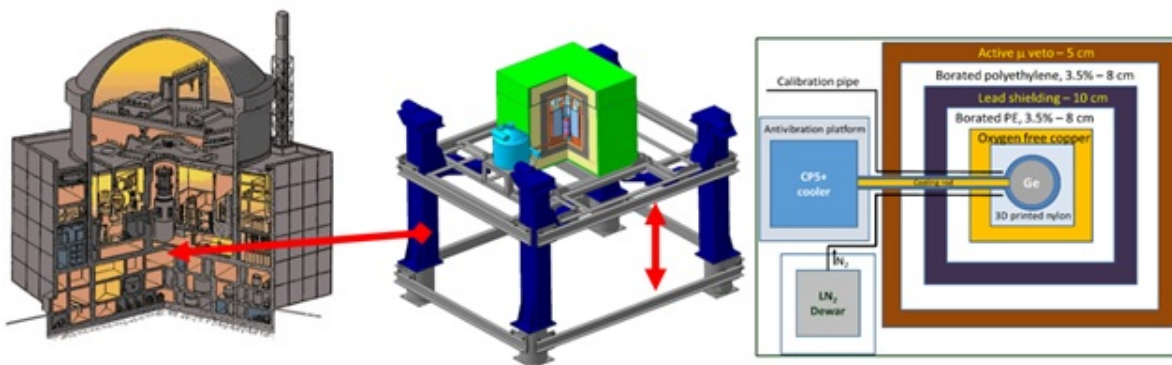

**Fig. 19.** Scheme of the vGeN setup aimed at detecting CEvNS. The setup is located directly under the KNPP reactor #3 (left), on a special lifting device (center) that allows changing the antineutrino flux in the HPGe detector, surrounded by a complex active and passive shielding (right)

The scientific programme of the actively developing Baikal-GVD neutrino project includes the study of a number of fundamental problems:

- registration and study of neutrinos from astrophysical objects in the Southern Hemisphere and, what is especially important, from the center of our Galaxy;
- determination of the sources of origin and clarification of the mechanisms of generation of cosmic particles of ultra-high (unattainable on Earth) energies (together with gamma astrophysics);
- search for signals from the annihilation of weakly interacting massive neutral particles of dark matter in the nearest space objects (the Sun, the center of the Galaxy, the Earth, Jupiter, etc.);
- search for heavy magnetic monopoles and other hypothetical particles of extraterrestrial origin (strangelets, supersymmetric, quark bunches, Q-balls, etc.);

– study of the angular and energy spectra of atmospheric neutrinos and muons (in addition to the main background for the above tasks, it also has independent significance, for example, from the point of view of studying the cross sections for the interaction of neutrinos with matter).

As an applied activity accompanying fundamental research, monitoring of hydro- and biophysical processes occurring in Lake Baikal will be carried out.

## NUCLEAR PHYSICS

In 2024–2030, the following main areas of research in the field of low-energy nuclear physics will be further developed: the synthesis of superheavy elements in reactions with heavy ions and the study of their nuclear physical and chemical properties, study of the mechanisms of nuclear reactions with heavy ions, study of the structure of nuclei located at the drip lines, basic research with neutrons, as well as applied research.

### **Synthesis of isotopes of superheavy elements and study of their nuclear physical properties**

In 2024–2030, an in-depth study of the nuclear physical properties of isotopes of superheavy elements with  $Z = 103 \div 118$  will be performed at the SHE Factory, including first measurements of the masses of heaviest nuclei, determination of the characteristics of their low-lying states, search for rare decay modes, as well as rare reaction channels. Experiments are planned to be performed on the synthesis of new elements with atomic numbers  $Z = 119$  and  $120$  on  $^{50}\text{Ti}$  and/or  $^{54}\text{Cr}$  beams. Considerable attention will be paid to experiments on the synthesis of new isotopes of superheavy elements to determine the borders of the "island" of increased stability.

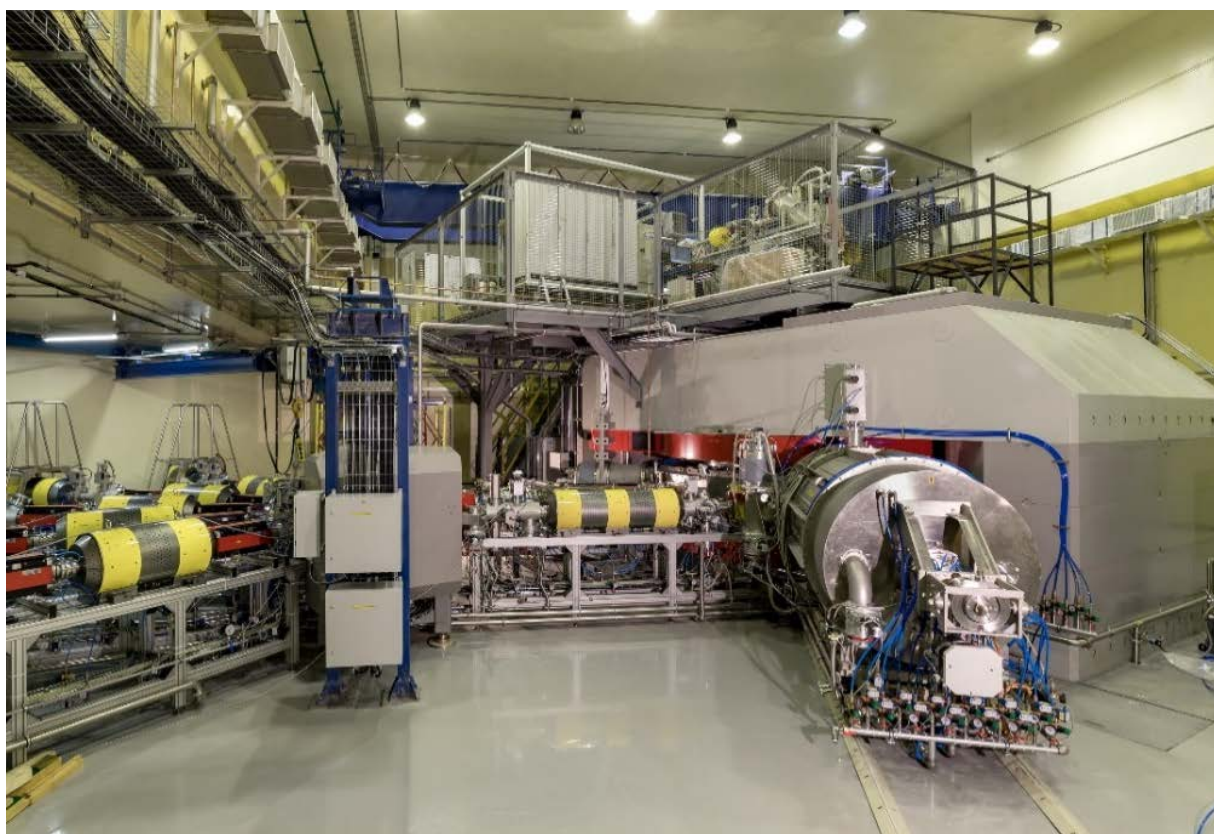

**Fig. 20.** DC-280 Cyclotron of the SHE Factory

### **Investigation of the processes of multi-nucleon transfers in collisions of massive nuclei, synthesis of new neutron-rich heavy nuclei**

Reactions of multi-nucleon transfers (MNTs) in near-barrier collisions of actinides are a promising method for the synthesis of new neutron-rich isotopes of heavy and superheavy elements. The deeply modernized U-400R accelerator complex, including a new experimental building, will create the necessary conditions for in-depth study of these and other low-energy nuclear reactions with heavy ions. The development and construction of new facilities for the implementation of the FLNR research program for studying nuclear

reactions should be carried out in the coming years. The FLNR program in the field of MNTs will be aimed both at studying the mechanisms of these reactions, focused on collecting kinematically complete information about specific reaction channels, and at using MNTs as a method for obtaining and studying new (mainly neutron-enriched) isotopes of heavy and superheavy elements. In the latter case, the facilities should be able to separate and allow the study of long-lived neutron-rich nuclides of elements up to  $Z = 101$ – $110$ . The synthesis of these nuclides will also allow conducting chemical studies in liquid phase.

For wide application of multi-nucleon transfer reactions to the synthesis of the heaviest nuclei, high-intensity uranium beams are required. The development of a new 28 GHz ECR ion source will be essential to support these studies. The planned experimental study of MNT reactions must be accompanied by the active development of appropriate theoretical approaches.

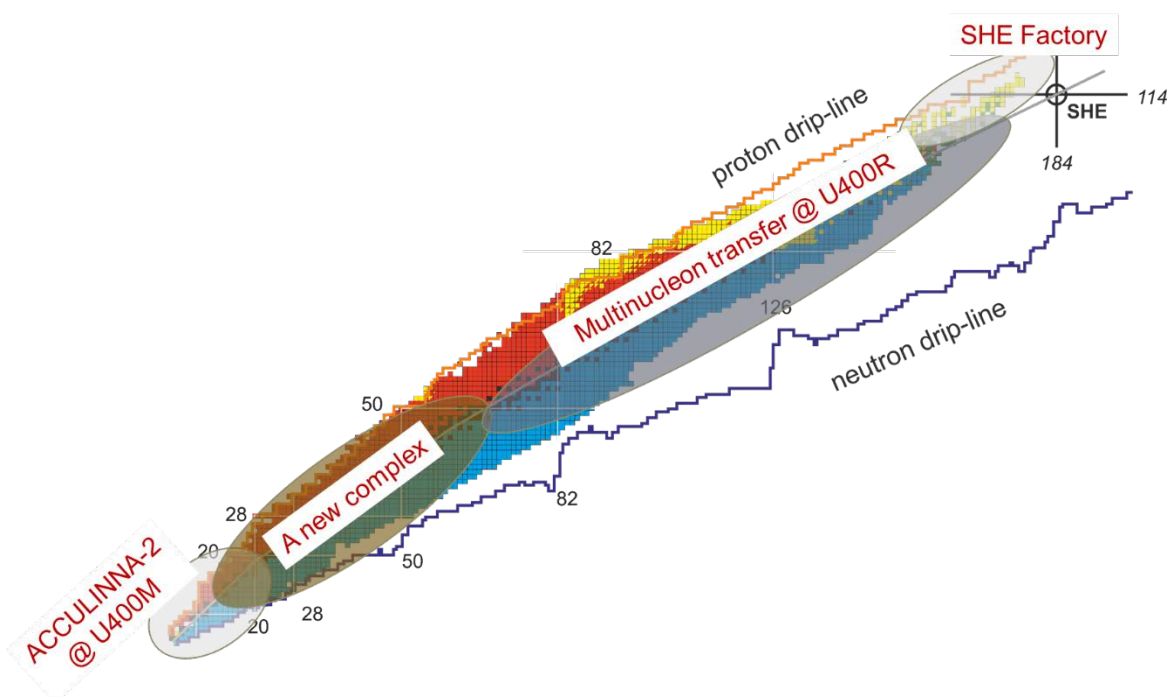

**Fig. 21.** Methods for obtaining nuclei in different areas of the nuclear map, developed at FLNR

### Nuclear structure of transfermium elements

In 2024–2030, the program for  $\alpha$ -,  $\beta$ - and  $\gamma$ -spectroscopy of the heaviest nuclei will continue to be implemented at the upgraded multiparameter detector complex GABRIELA (SHELS velocity selector, U-400R accelerator). For the first time, the region of superheavy element isotopes in the island of stability becomes available for nuclear spectroscopy experiments. These experiments will be carried out with the DGFRS-3 separator (GRAND) at the SHE Factory.

### Development of the study of SHE chemical properties

Further development of research on the chemical properties of superheavy elements requires a significant increase in the performance of the facility from units to hundredths of a second. For these purposes, a new specialized pre-separator based on a gas-filled solenoid is being created at FLNR. In addition, the development of devices for the transportation and separation of nuclear reaction products, primarily a superconducting solenoid, as well as measurement and recording systems, will continue. At these devices, both "traditional" experiments to study the properties of SHE in the elementary state and the behavior of their chemical compounds will be performed at a new methodological level. Chemical experiments will

focus, in particular, on the study of the properties of Nh and Mc. Another important task is to set up the first-ever experiments for Mt, Ds and Rg.

### **Study of the properties of heavy and superheavy nuclei by precision mass spectrometry and laser spectroscopy**

Performance of the world's first experiments on precision measurement of the masses of superheavy nuclei will require significant development of the experimental base of the SHE Factory. In 2024–2030, it is planned to create a complex that includes the existing gas-filled separator GRAND, a cryogenic gas catcher and a multi-reflection time-of-flight mass analyzer. The task is to measure the masses of superheavy nuclei with a resolution of  $10^6$  and higher. The time-of-flight mass spectrometer can serve as the first stage for the Penning trap, which allows the analysis of isotopes by mass with a resolution of  $\sim 10^{10}$ . In addition, in the next seven years we intend to develop methods of ionization laser spectroscopy inside a gas cell, which will allow us to carry out pioneering experiments to determine the first ionization potential of transfermium elements.

### **Study of the mechanisms of reactions with stable and radioactive nuclei, search for new decay modes**

The aim of research with radioactive beams (RIB) is to expand knowledge about the chart of nuclides from nuclear stable isotopes to the limits of the existence of a nuclear structure. Secondary beams of radioactive isotopes far from the stability line will complement the studies of superheavy elements conducted at FLNR.

In the last 2–3 decades, bright results related to the structure of neutron-rich nuclear systems, such as  ${}^4\text{--}7\text{H}$ ,  ${}^5\text{--}10\text{He}$  and other isotopes located at the borders of nucleon stability, have been obtained at FLNR. A number of new complex experimental approaches and techniques have been developed. In particular, a unique cryogenic tritium target complex has been developed at the Laboratory to populate the low-energy spectra of the nuclei of interest.

The JINR FLNR will ensure the continuation of experimental research in the field of light exotic nuclei located at the borders of nucleon stability, including the study of cluster states, exotic multi-neutron decays, two-proton radioactivity, the search for new magic numbers and spectroscopy of exotic nuclei, reactions with halo nuclei.

FLNR is currently considering two main ways to expand the long-term RIB technology development programme for the next seven years and beyond. The most ambitious, in terms of the scope of the research programme, and, at the same time, the most expensive project involves the construction of a high-precision continuous linear accelerator for producing heavy-ion beams with energies up to 100 A MeV. Such an energy of ion beams with an intensity of 1  $\mu\text{A}$  particles for U and  $>10 \mu\text{A}$  particles for lighter nuclei will make it possible to increase the intensity of secondary beams by several orders of magnitude, as well as to produce and study the isotopes most distant from the beta stability line. The E1-E2 project based on a tandem of two cyclotrons, which are under preparation at FLNR, also involves the production of heavy-ion beams with energies up to 100 A MeV.

The third proposal implies the use of the modernized U-400M accelerator as a driver, the primary beam stop in a thick target, extraction of exotic nuclei ions, transport and subsequent pre-acceleration at the U-400R cyclotron. Secondary beams in a wide energy range of 0.8–28 A MeV with an intensity of up to  $10^9 \text{ s}^{-1}$  can be used to study the structure of exotic nuclides in transfer and recharge reactions, search for rare decays



with an active target (the project is under development), and study of reactions, which are of interest to astrophysics. The secondary beams will be transported to the new experimental hall of the U-400R cyclotron.



**Fig. 22.** ACCULINNA-2 fragment separator

In the next decade, the experimental program on radioactive beams will be implemented mainly with the ACCULINNA-2 fragment separator of the U-400M cyclotron complex, which underwent a deep modernization in 2020–2023. The ACCULINNA-2 separator is equipped with a number of tools, such as a radio-frequency filter for additional purification of secondary beams, a zero-angle spectrometer for separating charged reaction products, a neutron wall based on stilbene crystals, etc. A new cryogenic gas target (hydrogen isotopes, including tritium, and helium) is expected to be commissioned by 2024. The 7-year period includes, in particular, the study of exotic nuclear systems such as  $^{10}\text{He}$ ,  $^{13}\text{Li}$ ,  $^{16}\text{Be}$ ,  $^7\text{B}$ ,  $^{26}\text{S}$ ,  $^{15}\text{Ne}$  in  $2n$ -,  $2p$ -transfer reactions with tritium and  $^3\text{He}$  targets. Some of these nuclei have already been the subject of research on ACCULINNA-1, 2 separators, which showed the need for additional statistics and improved energy resolution.

### **Applied research on heavy-ion beams**

In 2024–2030, applied research is planned to be developed based on the U-400R, U-400M, DC-140 heavy-ion accelerators and the MT-25 electron accelerator.

In the field of research on radiation resistance of materials and radiation damage physics, work will be carried out on the study of radiation resistance of nanostructured ceramics, and oxides, high-entropy alloys and dispersed oxide-hardened steels to heavy ions with energies of fission fragments. Particular attention is planned to be paid to the study of the long-term stability of materials of interest for use as target substrates in experiments on the synthesis of superheavy elements.

In the field of track membranes and the creation of new nano- and microstructured functional materials, research will focus on the most in-demand areas related to life sciences, energy-saving technologies and environmental protection. Using hybrid technologies, membranes will be developed for new separation processes, for specific medical and biological applications, and for highly sensitive analysis methods (sensors).

A new generation of sensitization setups for ion-irradiated polymer films and chemical etching setups will be created and put into operation. It is planned to develop a fleet of equipment for comprehensive support of all developments, including methods of elemental analysis, studies of the morphology of materials, physical and mechanical tests, etc.

## Nuclear physics with neutrons

Many tasks of nuclear physics with neutrons require high resolution and a very narrow neutron pulse, less than one microsecond (provided by IREN). However, there is also a wide range of problems for long pulse sources with a high neutron flux. In particular, such sources can be useful for experiments aimed at detailed research or search for new effects that violate fundamental symmetries (P-odd and T-odd effects). These experiments usually require neutron beams with a high degree of polarization, which is achieved more easily for low-energy resonances (it is possible to use IBR-2 beams). A separate niche is occupied by research using the tagged neutron method with a neutron (D-T) generator. This technique opens up new possibilities for studying inelastic reactions with neutrons at 14 MeV and is in demand both for solving problems of nuclear physics and for a wide range of applied problems.

The seven-year plan suggests focusing on solving the following physics problems in the field of **nuclear physics with neutrons**.

1. Comprehensive study of the nuclear fission process: measurement of mass-energy and angular distributions of fragments, fast neutrons and gamma-rays; measurements of delayed neutrons and gamma-rays; search for rare and exotic fission modes (ternary, quaternary and quintuple fission; fission into three fragments of comparable mass; formation of pions during fission, cold fragmentation, etc.); study and search for P-odd and T-odd effects in fission.

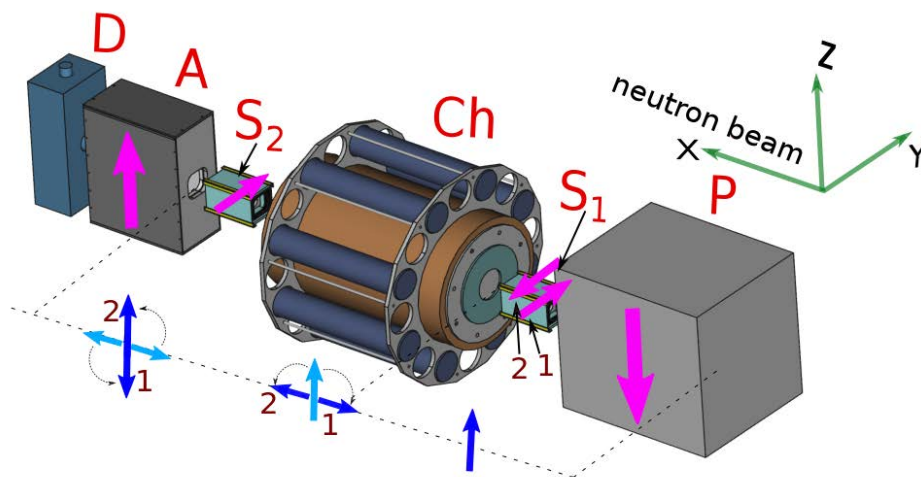

**Fig. 23.** Scheme of the experiment for measuring T-odd effects in fission. P – SEOP polarizer; Ch – fission chamber surrounded by gamma detectors; A – analyzer; D – neutron detector; S1, S2 – spin control devices. The pink arrows in the figure indicates the direction of the magnetic field, the blue arrows – the direction of the neutron spin

2. Studying the properties of neutron resonances. Measurement of gamma-ray spectra for resonances with different spins, parities and angular momenta. Study and search for P-even and P-odd effects in neutron resonances. Search for p-wave resonances in which time invariance violation can be expected.

3. Obtaining data for nuclear engineering and astrophysics: measurement of integral and differential neutron cross sections, angular correlations in the energy range from that of cold neutrons to  $\sim 1$  GeV.

4. Development and application of the tagged neutron method for studying reactions of fast neutrons with nuclei.

5. Development and application of neutron and nuclear methods for elemental analysis and applied research: instrumental activation analysis; prompt gamma-ray analysis; elemental analysis by fast and tagged neutrons; elemental analysis of surface layers of solids.

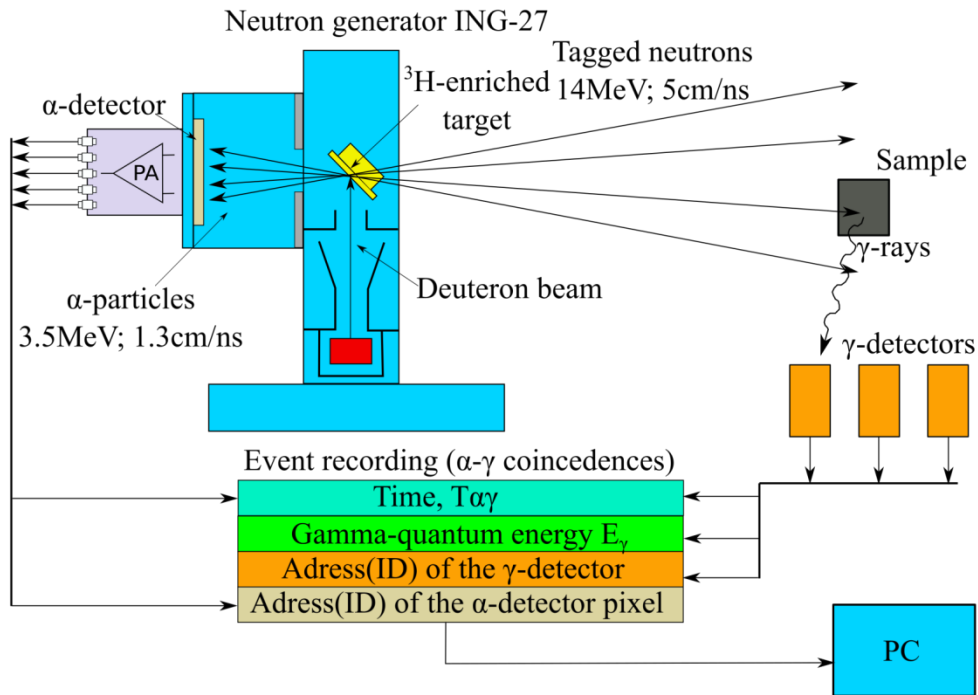
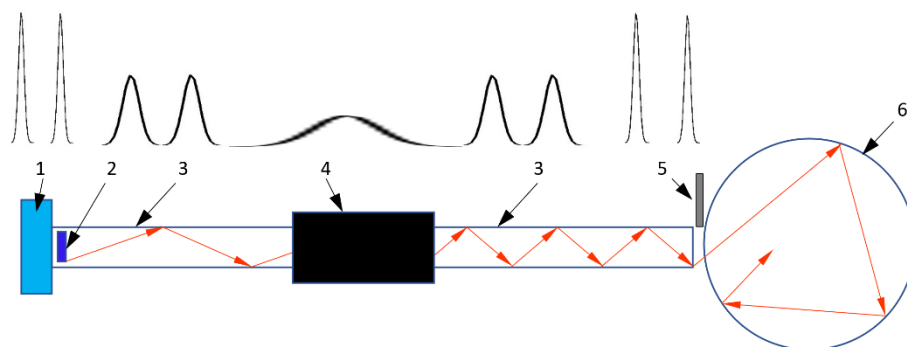

**Fig. 24.** Scheme of experiments using the tagged neutron method to study the interaction of fast neutrons with nuclei

### Development of a new UCN source at the IBR-2 reactor

Ultracold neutrons (UCN) have shown themselves to be a powerful tool for solving problems of particle physics and studying fundamental interactions. The region of very cold neutrons (VCN) adjacent to the UCN looks very promising for the implementation of an experiment to search for neutron–antineutron oscillations, to measure the neutron lifetime.

Theoretically, it has already been shown that the UCN density can be significantly increased and approach the value corresponding to the peak power, rather than the average power of a pulsed neutron source. The development of such a UCN source at the IBR-2 reactor, which will provide an unprecedented UCN density (UCN factory), will be the main task in this area within the framework of the seven-year plan. Its creation will allow improving the accuracy of measuring the neutron lifetime, conducting research based on precision spectroscopy of neutron gravitational levels, improving limits on the electric dipole moment of the neutron, etc.



**Fig. 25.** The idea of an UCN source for a pulsed source using time focusing: 1 – moderator; 2 – UCN converter; 3 – mirror neutron guide; 4 – focusing device; 5 – fast shutter; 6 – UCN trap

## CONDENSED MATTER PHYSICS

JINR has a unique experimental base (the IBR-2 pulse reactor and the DRIBs-III accelerator complex) for conducting basic and applied research in the field of condensed matter physics and related fields (biology, medicine, materials science, etc.) aimed at studying the structure and properties of nanosystems and new materials, biological objects and biotechnologies. Since the previous seven-year plan, the studies of condensed matter have been supplemented with optical methods, in particular, based on the Raman microspectrometer “CARS”.

### Neutron and complementary research methods

Neutron methods of studying matter make it possible to obtain comprehensive information about the atomic and magnetic structure and dynamics of materials at the atomic and subatomic levels. Due to the peculiarities of the interaction of slow neutrons with matter, neutron scattering is the most powerful technique to locate light atoms among heavy ones, to study the distribution of elements with close atomic numbers, and to investigate isotope substitution processes and magnetic structures. For more efficient solution of the tasks, along with neutron methods, complementary methods of X-ray diffraction, optical, atomic force spectroscopy, etc., will also be used.

It is planned to study functional materials — multiferroics, alloys with giant magnetostriction and shape memory effects, low-dimensional and geometrically frustrated magnets exhibiting unusual magnetic states and properties, materials promising for use in compact electric current sources, magnetic layered nanostructures demonstrating various proximity effects, for example, the coexistence of superconducting and magnetically ordered states, organic functional materials with hydrogen bonds, complex fluids and polymers with a wide range of potential technological applications, the structural organization and properties of which can change significantly with changes in concentration and chemical composition, biological nanosystems, including lipid membranes, proteins and their complexes, the study of which makes it possible to understand the biophysical processes occurring in living organisms, the mechanisms of action and transfer of drugs, the causes of various diseases, and biohybrid materials, structural materials that are widely used or planned to be used in various industrial and manufacturing processes.

### Expected results

#### 1. Condensed matter physics and materials science

- Determination of the characteristics of the atomic and magnetic structure and phase states of various functional materials: intermetallic compounds, magnetostrictive alloys, shape memory alloys, oxides, low-dimensional magnetic materials.
- Analysis of structural and microstructural states of solid electrolytes and electrodes for metal-ion batteries, dynamics of functional materials with molecular complexes and ionic liquids.
- Analysis of the effects of the crystalline electric field (CEF) and magnetic dynamics in strongly correlated electronic systems.

#### 2. Physics of nanosystems and nanoscale phenomena

- Establishment of phenomena and effects associated with the coexistence of magnetism and superconductivity in layered structures based on transition and rare-earth metals and actinide compounds.
- Determination of the structural characteristics of carbon nanomaterials, thin films of single-walled carbon nanotubes on substrates. Investigation of the role of the nanotube–substrate interface.

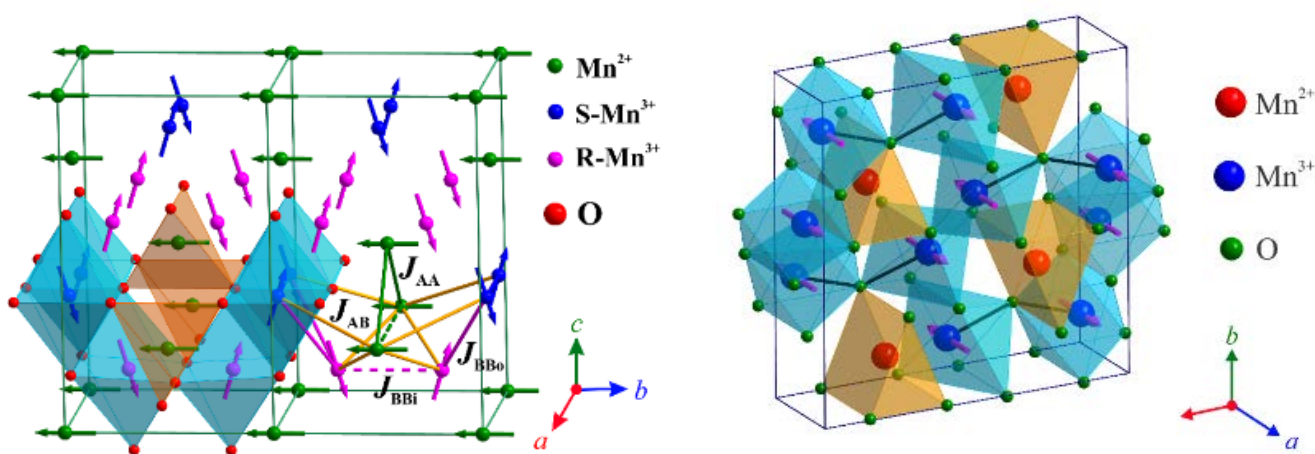
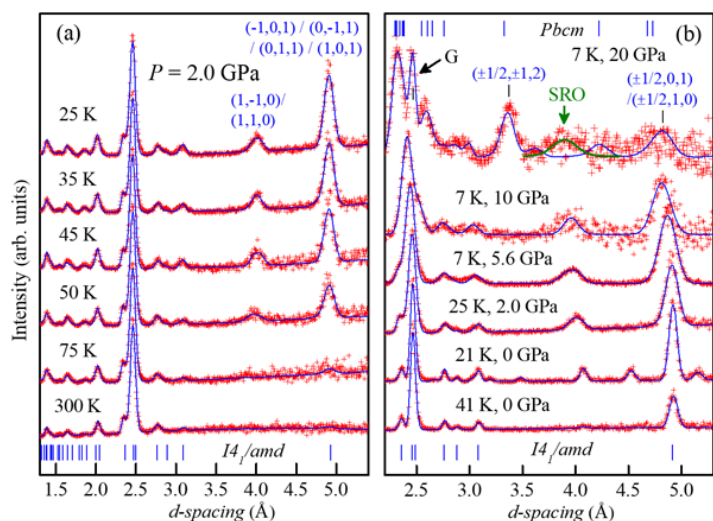

**Fig. 26.** Pressure-induced colossal enhancement of magnetic-ordering temperature in geometrically frustrated  $\text{Mn}_3\text{O}_4$  oxide

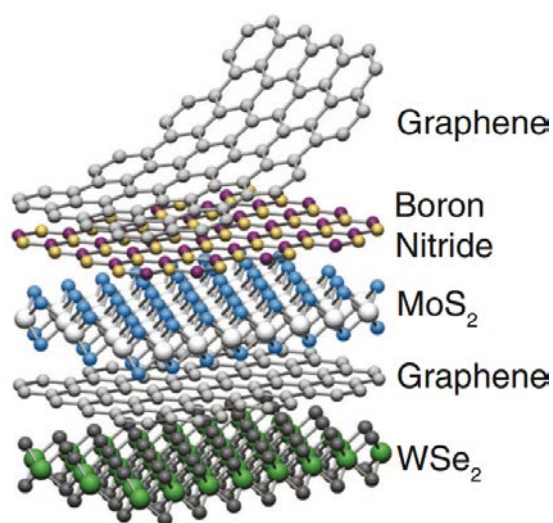

**Fig. 27.** Research on graphene and other two-dimensional atomic crystals is intense and is likely to remain one of the leading topics in condensed matter physics and materials physics in the coming years

### 3. Physics of complex liquids and polymers

- A comprehensive study of the structure and kinetics of aggregation in solutions of fullerenes of different polarity.
- Analysis of the structural features of magnetic nanosystems, including colloidal nanosystems and magnetic fluids.
- Determination of the structural characteristics of polymer systems on substrates, surfactant micelles in bulk and on the surface, surfactant complexes and micelles.
- Analysis of the structural organization of polymer nanomaterials, glass transition of polymers and polymer thin films.

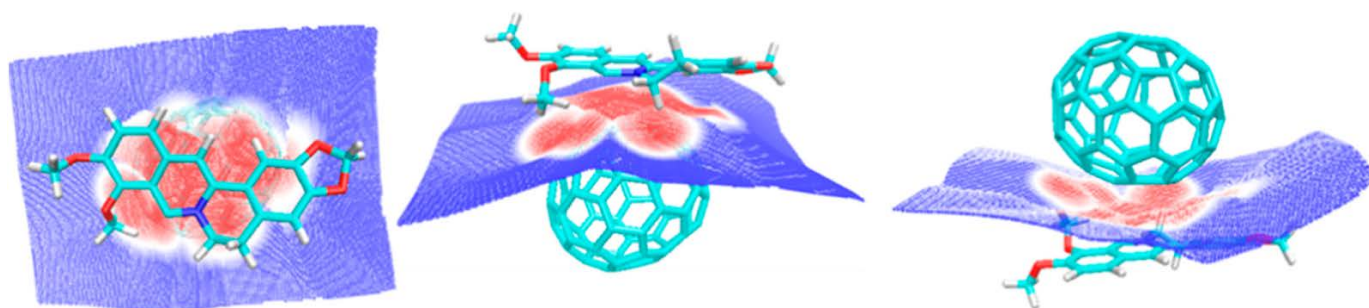

**Fig. 28.** Studies of the bioactivity of fullerenes

### 4. Biophysics and pharmacology

- Analysis of the physico-biological properties of lipid and native membranes, protein interactions, structure and properties of proteins and membrane-protein complexes, crystallization of proteins and biohybrid complexes.

### 5. Applied materials science and engineering sciences

- Determination of internal stresses and micro-deformations, as well as texture analysis in structural materials and bulk products, geological and biological objects.
- Analysis of the internal structure and construction of 3D models of objects of cultural and natural heritage, industrial materials and products according to neutron tomography and radiography data, nuclear forensic sciences and evidence research.

Condensed matter studies based on synchrotron radiation scattering will be carried out using sources existing in Russia and in the world, including at the National Synchrotron Radiation Centre SOLARIS of the Republic of Poland. The main areas of research are related to the analysis of the crystal structure of biological macromolecules and its role in the interaction of amyloid peptides with cell membranes of neurons.

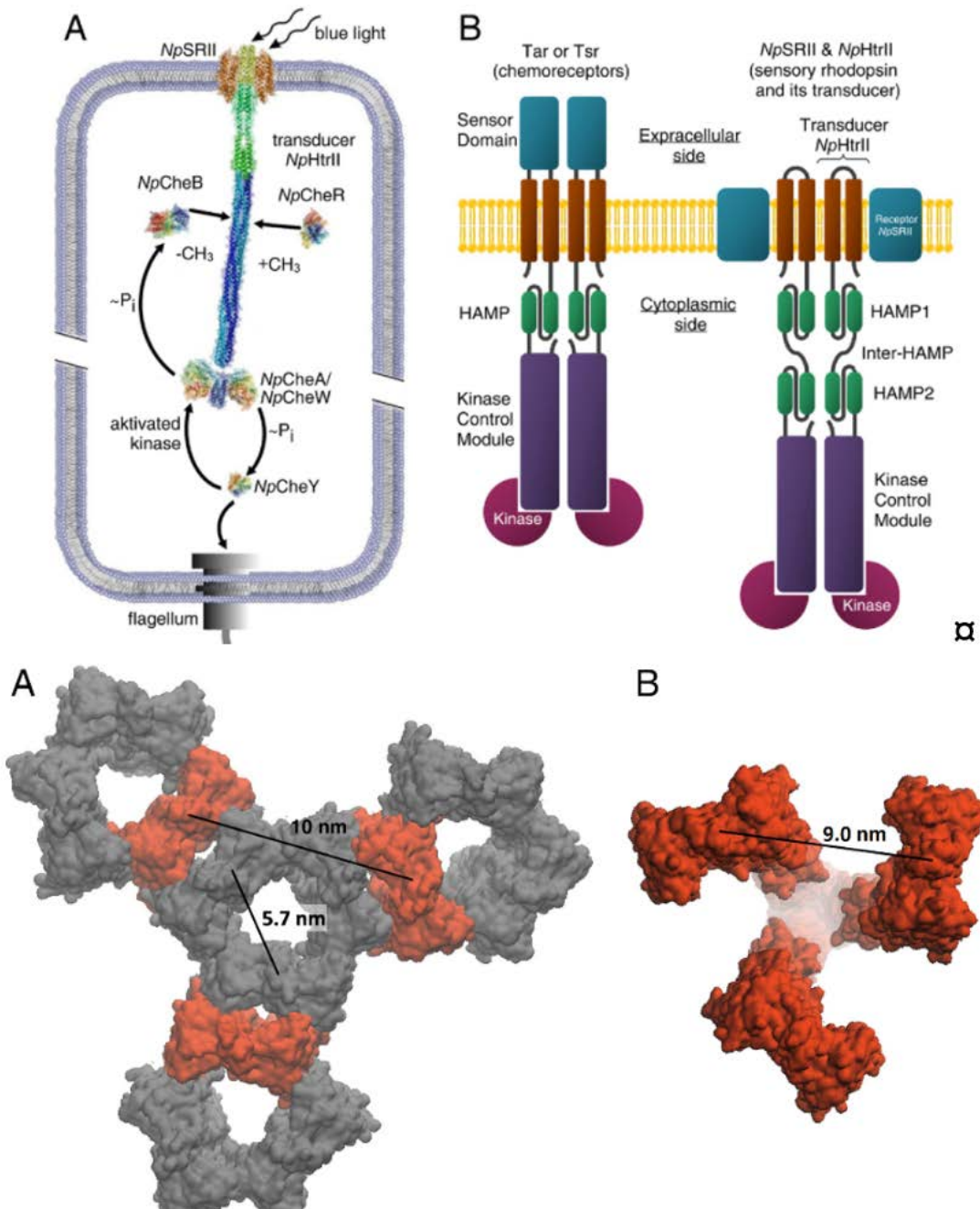

**Fig. 29.** Study of the structure of a full-length photoreceptor complex of sensory rhodopsin with its cognate transducer from the extremophilic archaeon *Natronomonas pharaonis*. Top: Signal transduction pathway (A) in case of the TCS negative phototaxis of *N. pharaonis* and domain architecture (B) of the chemoreceptor dimer (Tar and Tsr in complex with kinases) from *E. coli* (left) and of the complex of rhodopsin II with its cognate transducer NpHtrII from *N. pharaonis* (right). Bottom: images of transmembrane domains of the NpSRII/NpHtrII complex: (A) fragment of hexagonal packing of “O”-shaped trimers of dimers; (B) “tripod”-shaped model of the trimer of dimers

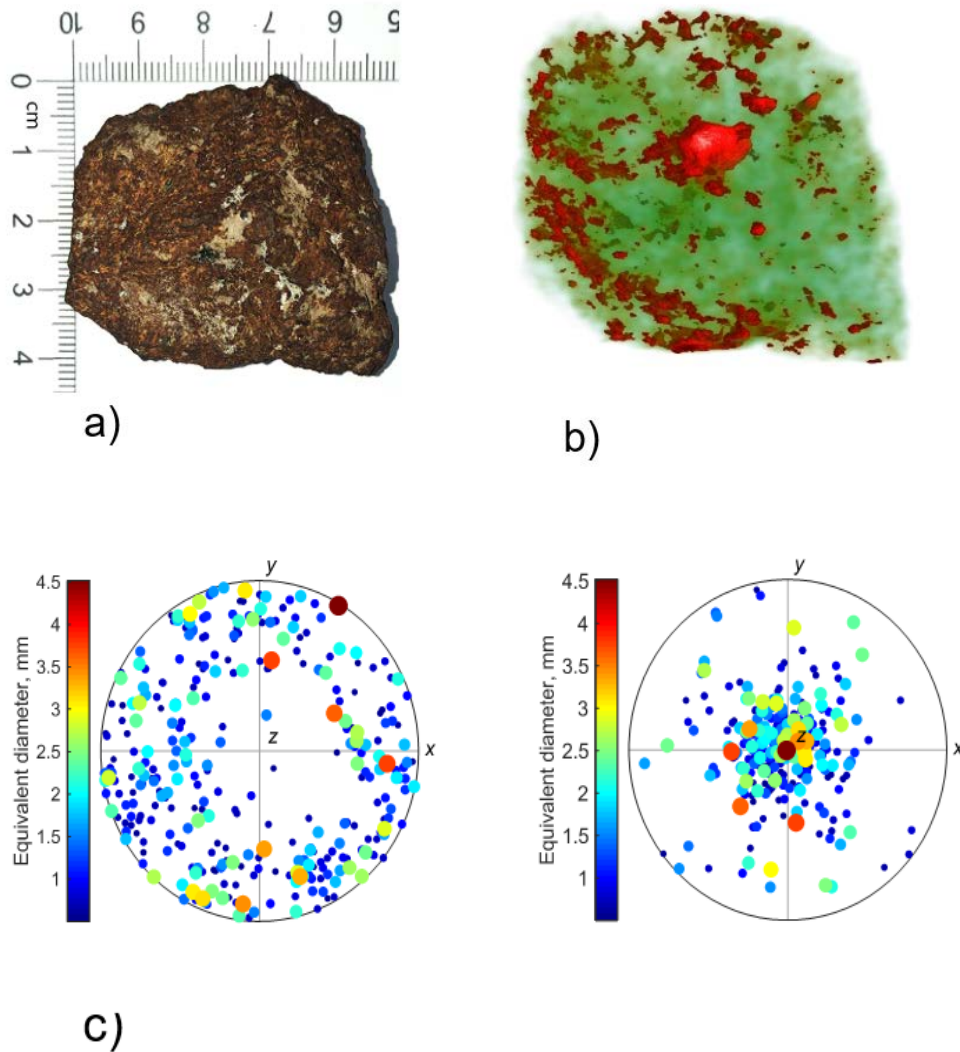

**Fig. 30.** Study of the internal structure and phase composition of a fragment of the Kunya-Urgench chondrite meteorite, known as the “Turkmenbashi meteorite”, which is one of the three largest known meteorites in the world. Photo (a) and a three-dimensional model (b) of a fragment of the Kunya-Urgench meteorite reconstructed from the neutron tomography data. Iron-nickel metallic components are marked in red. The pole figures of orientation of the main axes of inertia of the particles of FeNi kamacite of the Kunya-Urgench meteorite are also presented (c). The size of the symbols is proportional to the equivalent diameter of the metal particles

### Optical methods of research

Raman spectroscopy is a powerful analytical tool based on inelastic scattering of radiation incident on a sample, which has wide application in materials science, nanotechnology, ecology, criminology, life sciences and many other areas where non-destructive structural analysis and spectral-selective visualization of samples are required.

FLNP successfully operates a multimodal optical platform on the basis of a laser scanning confocal microspectrometer CARS, which allows spectroscopy and microscopy of various materials (solids, liquids, powders, biological samples, etc.) based on spontaneous Raman scattering (RS) of light. Research in 2024-2030 will focus on a number of basic and applied problems with a trend towards life sciences.



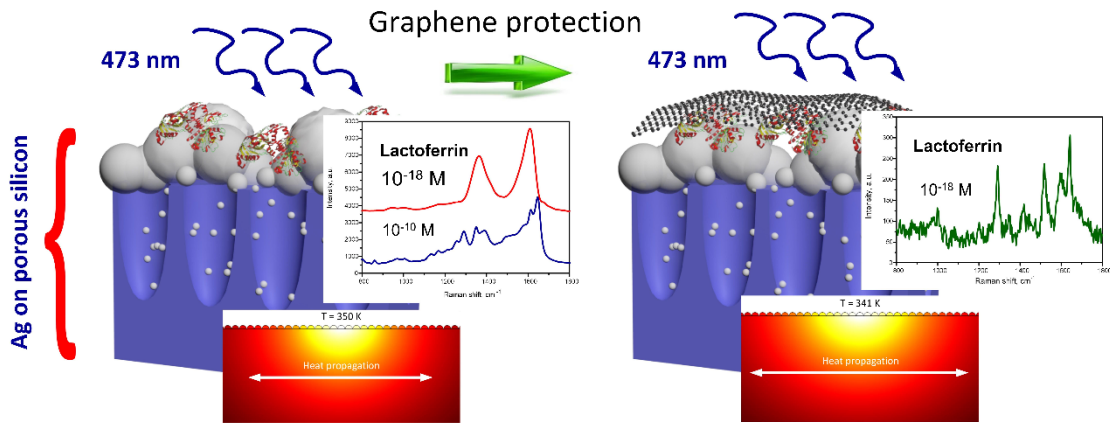

**Fig. 31.** Biosensing: ultrasensitive detection of organic molecules

## Expected results

### 1. Life sciences:

- biosensorics: development of new efficient plasmonic substrates for highly sensitive SERS spectroscopy;
- lipid–protein interactions: detection of spectral/conformational changes in the secondary structure of peptides embedded in membrane mimetics.
- optical studies and fluorescence spectroscopy of programmed cell death – netosis.

### 2. Enhanced Raman microspectroscopy:

- application of CARS and SERS spectroscopy for the study of two-dimensional materials and van der Waals heterostructures: prospects for their use in sensors and optoelectronics.

## **RADIATION RESEARCH IN LIFE SCIENCES**

Radiation sources, and above all, heavy-ion beams of various energies obtained at JINR's basic facilities, will be used for basic research in radiobiology, astrobiology, neurophysiology, molecular biology, and genetics, as well as for applied research for radiation medicine and radiation risk assessments on Earth and in space.

The radiobiological experiments planned at the Institute's nuclear physics facilities will be conducted in the following main areas of research.

### **Molecular radiobiology**

Studies of the formation and repair of clustered DNA damage after exposure of normal and tumor cells of mammals and humans to radiations of different quality.

### **Radiation genetics**

Studies of the formation of gene, structural, and complex mutations in mammalian and human cells after exposure to radiations with different characteristics.

### **Radiation physiology**

Studies of behavioral reaction disorders and pathomorphological changes in various brain structures, critical organs, and systems of irradiated animals under normal conditions and in the presence of radioprotectors.

### **Neuroradiobiology**

Studies of the mechanisms of neurodegeneration under the action of ionizing radiations of different quality.

### **Medical radiobiology**

Development of new approaches to improving the biological effectiveness of radiation therapy of tumors and methods of targeted delivery of radiopharmaceuticals.

### **Mathematical modeling**

Development of a hierarchy of mathematical models to describe radiation-induced effects at different levels of biological organization and time scales.

### **Radiation research**

Upgrade and development of new irradiation facilities for radiobiological experiments. Assessment of radiation risks at the Institute's basic facilities and on board spacecraft. In particular, the NICA complex will continue work on forecasting the radiation conditions at the facility and in the environment, assessing the levels of induced activity of equipment, assessing personnel exposure, organizing radiation safety measures, and creating radiation monitoring systems.

### **Astrobiology**

Research of pathways of synthesis of prebiotic compounds under the action of radiation; search for microfossils and organic compounds in meteorites.

**U-400M cyclotron**  
heavy ions 50 MeV/u



**Infrastructure**  
for cellular and animal research

Microscopy  
Tomography  
OMICS



Vivarium

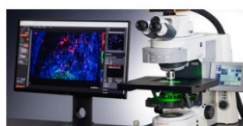

**Nuclotron**  
heavy ions 0.15–1 GeV/u

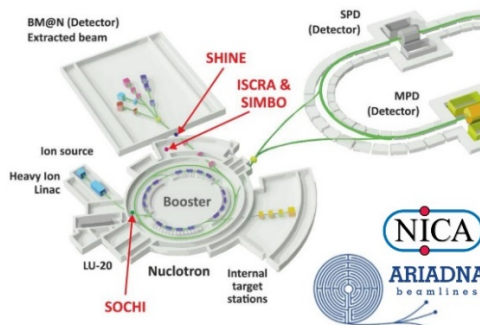

**MSC230 cyclotron**  
protons 230 MeV



**Linac200**  
electrons 20–200 MeV

**MICC**  
SC Governor



**SARRP** X-ray

**FLNP** IBR-2, IREN neutrons

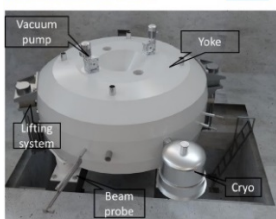

**Fig. 32.** JINR infrastructure facilities for fundamental research in radiobiology, astrobiology, neurophysiology, molecular biology and genetics, as well as for applied research in radiation medicine and radiation risk assessment on Earth and in space

### Expected results

1. Establishment of integrative interrelations of radiation-induced effects at different levels of biological organization: molecular, cellular, tissue and organismal ones under the action of radiations with different characteristics.
2. Identification of the mechanisms of the effect of ionizing radiations of different quality on the higher integrative functions of the central nervous system and the development of neurodegenerative diseases.
3. Assessment of radiation risks for various scenarios of manned space flights and mixed radiation fields of nuclear physics facilities.
4. Development of new methods to improve the effectiveness of radiation and radionuclide therapy of malignant neoplasms.
5. Development of new mathematical models and computational approaches for radiobiology, bioinformatics, and radiation medicine.
6. Identification of mechanisms and pathways of catalytic synthesis of prebiotic compounds under the action of radiation.
7. Development of new research protocols in radiobiology, including omics technologies, ultra-high resolution bio-imaging, new irradiation facilities, and automated processing of biological data based on artificial intelligence technologies.

### Equipment and infrastructure development

The key to the successful implementation of the international programme of radiobiological and astrobiological research is the possibility of conducting experiments at JINR nuclear physics facilities, including heavy-ion beams at the VBLHEP (the SIMBO station at the ARIADNA@NICA complex) and FLNR (the Genom-M facility at U-400M); proton beams at MSC-230 and LINAC-200 at the DLNP; and

neutron beams at the FLNP (IBR-2, IREN, and EG-5). The need for machine time is up to 100 hours per year for each accelerator. The MLIT computing complex resources are also required for calculations (CPU+GPU), storage, and automated processing of biological data (storage capacity of up to 1 PB).

The gradual development of the infrastructure for biological research at the LRB, as the international research programme expands and is provided with resources from collaborations, involves:

- 1) Commissioning of equipment for molecular and cellular omics studies (mass spectrometers, high-performance sequencer, flow cytofluorimeter sorter, laser confocal scanning microscope, etc.);
- 2) Upgrade of the vivarium; design and commissioning of equipment for animal tomography (optical, fMRI, SPECT/PET);
- 3) Design, construction, and licensing of radiochemical units for research on cell cultures and laboratory animals;
- 4) Design, creation, and commissioning of a microbeam and compact ionizing radiation sources for precision irradiation of cells and animals;
- 5) Design, construction, and installation of a simulator for modeling complex radiation fields; purchase of spectrometers and dosimetry equipment.

## THEORETICAL PHYSICS

Research in theoretical physics conducted at BLTP has an interdisciplinary character; it is distinguished by deep integration into international projects with the participation of scientists from the world's main research centers and close coordination with experimental programs at the JINR basic facilities.

### Quantum field theory and elementary particle physics

In theoretical research on elementary particle physics, active participation will continue in the elaboration and development of physical programs for JINR basic facilities, primarily the NICA/MPD and NICA/SPD projects, as well as international experimental collaborations with the participation of the Institute. The focus will be on the phenomenology of the Standard Model, including a detailed study of the properties of the Higgs boson, as well as the search for new physical phenomena beyond the Standard Model. Multi-loop calculations will be carried out within the framework of the Standard Model and beyond, both in application to the observables and to further clarify the structure of the quantum field perturbation theory. In the field of neutrino physics, special attention will be paid to the detailed study of interactions with nucleons, which is crucial for supporting experiments, particularly and especially, the Baikal experiment. Factorization methods will be developed and used in studies of hadron structure and spin physics, as well as calculations for specific experimental conditions, in particular, NICA/SPD will be carried out. Phase transitions in hot and dense hadronic matter will be investigated using lattice calculations, kinetic and hydrodynamic models, as well as theoretical methods based on the properties of quantum anomalies. The physics of heavy flavors and hadron spectroscopy will be developed using both quantum field methods and models designed at JINR. Record-breaking precision calculations in the field of atomic spectroscopy will be continued. Special attention will be paid to the astrophysical aspects of particle physics using modern observational data, in particular, the problem of dark matter.

### Nuclear theory

Research in the field of low-energy nuclear physics will focus on the study of exotic nuclei in the regions of superheavy elements and light nuclear systems at the borders of stability and beyond, which are relevant for experimental research at the Superheavy Elements Factory of JINR FLNR and other world research centers. The nuclear dynamics of fusion and fission will be considered taking into account cluster degrees of freedom. It is planned to establish a connection between microscopic self-consistent and phenomenological models of the nucleus. The application of energy density functionals to describe nucleus–nucleus interactions, double  $\gamma$ - and  $\beta$ /EC-decay of heavy nuclei will be studied. Models will be developed to predict the rates of various nuclear reactions for astrophysical purposes. Nuclear reactions in the stellar environment will be studied by methods of few-body theory and the theory of open quantum systems. The mechanisms of transfer of nucleons, clusters between nuclei and of the decay of a nucleus in the field of the other one will be analyzed. The rigorous methods of few-body theory will be developed to study various quantum systems, including collisions of ultracold atoms in confined geometry of laser traps. The nonlinear effects in  $\gamma$ – $\gamma$  interactions will be duly taken into account for data analysis in the DESY experiments. Investigations of high-energy heavy-ion collisions will be conducted in close connection with the upcoming experiments at NICA/MPD. The color degrees of freedom will be considered using a model developed to account for the effect of the medium-modified quark–hadron interaction. Electron scattering on a trinucleon will be studied for the analysis of nucleon–nucleon interactions.

## **Condensed matter theory**

The most important areas of basic research will be the theoretical study of physical phenomena and processes in condensed media, the investigation of the properties of new perspective materials, the construction and analysis of theoretical models and the development of analytical and computational methods for their solution. It is supposed to study complex materials such as high-temperature superconductors, magnetic materials, smart composite materials, fractal and layered structures, analysis of a wide class of systems with strong electronic correlations. Theoretical research in this area will be aimed at supporting the experimental study of these materials conducted at the Frank Laboratory of Neutron Physics of JINR. Research is planned in the field of physics of nanostructures and nanomaterials, including using software packages for modeling physico-chemical processes and analyzing physical characteristics. These are primarily modern two-dimensional materials, such as graphene, transition-metal dichalcogenides, etc., taking into account their modification and chemical functionalization for subsequent use in the design of new devices for nanoelectronics, spintronics, etc. In part, these studies are focused on experiments conducted at the Center for Applied Physics of JINR FLNR, the Institute of Semiconductor Physics of SB RAS and a number of other laboratories of JINR Member States. The physical properties of Josephson junction stacks and various Josephson nanostructures will be investigated in detail. Much attention will be paid to the analysis of both lattice and field models of equilibrium and non-equilibrium systems of statistical mechanics. The concepts of scaling and universality allow us to go beyond the purely model approach and apply the results to a wide class of phenomena studied in condensed matter physics. It is expected to study a wide range of universal phenomena in complex systems – phase transitions in condensed media and high-energy physics, scaling in (magneto) hydrodynamic turbulence, chemical reactions, percolation, etc. using the methods of quantum field theory, including the functional renormalization group.

## **Modern mathematical physics**

The main objective of research in modern mathematical physics is to develop mathematical methods for solving the most important problems of modern theoretical physics, namely: the development of new mathematical methods for the study and description of a wide class of classical and quantum integrable systems and their exact solutions; analysis and search for solutions to a wide range of problems of supersymmetric theories, including models of strings and other extended objects; the study of nonperturbative regimes in supersymmetric gauge theories; the elaboration of cosmological models of the early Universe, gravitational waves and black holes. Mathematical physics is currently characterized by an increasing interest in identifying and effectively using the properties of integrability in its various areas, the use of powerful mathematical methods of quantum groups, supersymmetry and noncommutative geometry both in quantum theories of fundamental interactions and in classical models. When solving current problems, the use of these methods will be a decisive factor.

## **Research and Education Project “Dubna International Advanced School of Theoretical Physics (DIAS-TH)”**

The overall objective of the ongoing project “Dubna International Advanced School of Theoretical Physics (DIAS-TH)” will be the development of scientific and educational programmes at JINR. The unique feature of DIAS-TH is its deep integration into the scientific life of BLTP, which will ensure regular and natural participation of leading scientists in education and training activities, as well as organic incorporation of coming young personnel into scientific work. Development of cooperation with international and Russian foundations and state organizations will be essential to the successful implementation of the project.

Financial support for ISTC (International Scientific and Technical Cooperation) items and equipment are planned to a total of 5 million US dollars.

## INFORMATION TECHNOLOGY

JINR has the unique Multifunctional Information and Computing Complex, being a key component of the JINR network and information-computing infrastructure and playing a defining role in scientific research, which entails modern computing power and storage systems. Another important activity is the provision of mathematical, algorithmic and software support for experimental and theoretical studies underway at JINR.

### Mathematical support of studies performed at JINR

The aim is to simulate physical processes, to create algorithms and software systems for processing and analyzing experimental data, to develop algorithms in the field of machine and deep learning, artificial intelligence and cognitive intelligent robotics, systems of quantum intelligent control, the development of methods of computer algebra and quantum computing, as well as Big Data analytics.

### Expected results:

1. Development of information and computing systems for data analysis and processing in the field of radiobiology.
2. Development of algorithms based on recurrent and convolutional neural networks for machine and deep learning as well as Big Data analytics problems, created primarily to solve various tasks of particle physics experiments, including the NICA megaproject and neutrino experiments.
3. Creation of modern research tools for international collaborations (NICA, JINR neutrino program, LHC experiments).
4. Development of new numerical and computing models, including quantum computing, for theoretical research at JINR.
5. Elaboration of algorithms for intelligent control of JINR experimental facilities based on the quantum approach.
6. Development of a system on the Big Data analytics platform for the analysis and protection of data of the JINR computer network in real time based on network traffic.
7. Development of machine learning and artificial intelligence algorithms to optimize the functioning and intelligent monitoring of distributed computing systems.
8. Creation of a new-generation analytical system based on effective methods and algorithms of formalization, knowledge extraction and Big Data processing.
9. Development of intelligent information systems for research and applications.
10. Development of quantum IT data processing technologies with access to NISQ (Noisy Intermediate-Scale Quantum) computers/quantum computers with reliable error protection.
11. Development of scalable algorithms and software for processing multiparameter, multidimensional, hierarchical datasets of exabyte volume.

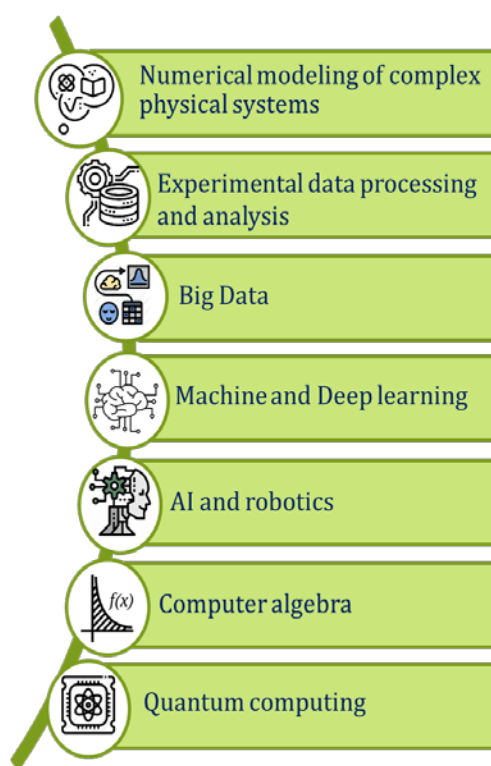

**Fig. 33.** Directions of development within the framework of mathematical support for research conducted at JINR

### JINR Digital Ecosystem

One of the uppermost tasks of the Seven-Year Plan is the creation of the JINR-wide digital platform “JINR Digital Ecosystem”. The main goal is the organization of a digital space with single access and data exchange between electronic systems, as well as the automation of actions that previously required a

personal or written request. The platform should ensure the integration of existing and future services to support the Institute’s scientific, administrative and social activities, as well as the engineering and IT infrastructures.

The user will have the possibility of a single entry point for the JINR digital environment, through which access to a large-scale network of different services will be provided. The “Digital Ecosystem” interface will represent a “showcase” of digital services and resources with the ability to perform a certain set of actions (for example, account management) or switch to a fully functional version of the service. Examples of services are resources for users of basic facilities, library services, document servers, MICC computing resources, IC administrative services (finance, personnel, electronic document management), etc.

Within the platform being created, registered users (with a JINR account, i.e., Single Sign-On, SSO) will be able to draw up and approve different documents in electronic form, to register and use scientific and administrative services without filling in paper forms and personally visiting the staff members responsible for them. A system of notifications from different services (for example, about documents that await signing) will be available in the personal account. The level of access to services will depend on the position of the staff member and his functional duties. A user-friendly interface allowing one to quickly update information will be organized for service administrators. Part of the resources will also be available to unregistered users: telephone directory, information on dissertation councils, scientific software, JINR map.

The JINR geoinformation system, including an interactive map, information on JINR buildings and other objects (plans of buildings, engineering and other networks, staff accommodation, accounting and analysis of the use of premises taking into account their class, type and purpose), etc. will be developed within the digital platform. The geoinformation system will enable to perform a quick and convenient search for information on both JINR buildings and staff members. It is supposed to use the technology of mobile robots and quantum control elements to solve the tasks of premises’ automatic explication (creating plans for buildings) and object localization on the map.

The platform should provide reliable and secure access to different types of data that arise in the course of the Institute’s work, from open to confidential. A sample dataset from key services will be placed in storage for further joint analysis using Big Data and artificial intelligence technologies. The automated monitoring of performance indicators for both individual objects and the Institute as a whole will be possible on the basis of data such as information about staff members’ publications, financial information and the use of computing resources.

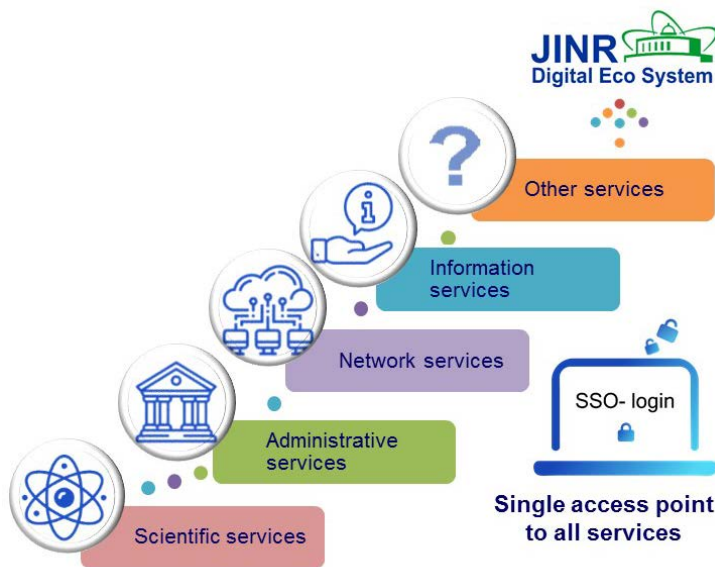

**Fig. 34.** JINR Digital Ecosystem

**Expected results:**

1. Creation of the platform “JINR Digital Ecosystem”.



## PHYSICS AND TECHNOLOGY OF CHARGED PARTICLE ACCELERATORS

The ambitious scientific program, which in a certain sense strengthened JINR on the world science landscape, in the field of high-energy physics, nuclear physics and condensed matter physics, implemented by international collaborations in Dubna, is based on the foundation of the unique experimental and accelerator facilities that we are developing. JINR has a modern fleet of basic facilities – sources of ionizing radiation (charged particle accelerators, charged particle sources, secondary radiation sources, transportation channels, unique stands): the NICA accelerator-collider complex at VBLHEP, the multifunctional complex of cyclic accelerators at FLNR, the LUE-200 linear electron accelerator and the EG-5 electrostatic generator at FLNP, the Linac-200(800) at DLNP. In fact, with the support of the Member States, international collaborations and users enjoy in Dubna the opportunity to work with the entire spectrum of particles (gammas, electrons, protons, ions, neutrons, polarized protons and deuterons) of various intensities and an energy range of 6 orders of magnitude (from kiloelectronvolts to gigaelectronvolts).

JINR has achieved worldwide recognition for its pioneering developments in beam physics and charged particle accelerators, as well as for the corresponding world-class scientific schools. Scientists and engineers of JINR are active participants and full-fledged co-authors of the projects of state-of-the-art international accelerator complexes: the LHC, XFEL, FAIR, RHIC, GANIL, INFN, J-PARC, ILC, CLIC, IMP CAS, HIAF, etc. Obviously, without a proactive development of frontier accelerator R&D, without the elaboration of new ambitious accelerator projects, it will hardly be possible to speak about the confident visibility and significance of the Institute and its scientific program in the 2030s–40s. Therefore, research in the field of beam physics and charged particle accelerators in the period 2024–2030 will focus on supporting R&D in the following areas:

- highly charged intense ion sources for generating heavy-ion beams with a charge state ( $Z > 40+$ ): superconducting electron beam (ESIS) and ECR sources (with a frequency of 28 and 45 GHz), ion sources based on highly charged ions in plasma generated by laser radiation pulses;
- superconducting magnetic technologies: strong-field magnets with fields up to 14–20 T, fast-cycling strong-field magnets ( $V > 4$  T, ramp  $> 4$  T/s), high-current cables and windings (increase in critical current density  $> 30$  kA) based on superconducting materials, including high-temperature ones;
- studies in the field of high-temperature superconductivity, development of Dubna superconducting cable technologies for a new generation of compact cyclic machines and solenoidal magnets;
- efficient fast cooling systems for intense hadron beams ( $\sim 10$ – $100$  ms);
- superconducting resonators (RFQ and DTL) and cryomodules of microwave structures for accelerating high-current proton and ion beams, including those operating in the low duty cycle and quasi-continuous mode at extremely low initial particle velocities;
- modeling and research work in the field of colliding beam accelerators: advanced solutions in the field of optical structures, collision effects, development of focusing elements with limit parameters and optimal field geometry, development of radiation-resistant focusing devices on permanent magnets;
- issues of implementation of future colliders (FCC, ILC, CPCC, etc.), high-precision laser metrological systems and feedback systems for the collision area;
- development of RF power systems based on solid-state power amplifiers and powerful klystrons;

- technologies of fast cycling synchrotrons for acceleration and accumulation of intense heavy-ion beams: ultrahigh vacuum, loss collimation, RF systems, effective stripping in targets, etc.;
- development of accelerator technology and special equipment for applied studies on extracted ion beams at the complexes of VBLHEP, FLNR, FLNP, DLNP.
- research and development work in the field of beam therapy: flash technology, pencil beam, study of prospects and development of technologies for the use of light-ion, neutron and electron beams;
- methods of deep machine learning for operation optimization and synchronization of systems of sophisticated accelerator complexes, for beam control and diagnostic systems;
- development of modeling methods (including using artificial intelligence methods) of beam dynamics with the “real” distribution of accelerating and focusing electromagnetic fields in accelerator structures, and taking into account online beam parameters (emittance, intensity, charge composition, etc.).

Progress in each of these areas will largely depend on the constructive coordination of priorities and resources for the implementation of the tasks listed above, work on which will be carried out in close cooperation with research groups and specialists from all the JINR Laboratories and Member States, including within the framework of a special All-Institute theme for the period 2024–2030.

The ambitious ion collider NICA is currently being prepared for launch at JINR. The project of the factory of intense radioactive beams is in the stage of feasibility studies. Low-energy research storage rings cost much less than large accelerator complexes, but can significantly expand the capabilities of many nuclear centers. The development of a new direction of ion-electron colliders will make it possible to obtain more accurate and reliable data on the structure of nuclei and processes in them for a wide range of different isotopes for which conventional physical methods are poorly applicable due to their small number and short lifetime. Such projects can serve as a basis for the development of the most advanced technologies and for training a new generation of physicists: ultrahigh vacuum, precision feedback systems, high requirements for the manufacturing precision of spectrometric accelerators will allow these technologies to be mastered in practice.

## **DEVELOPMENT OF ENGINEERING INFRASTRUCTURE**

The engineering infrastructure of JINR is a set of engineering networks, capital construction objects, industrial, nuclear physics facilities, equipment, technical devices and other installations providing production and scientific-technical activities of the Institute in compliance with the Charter.

The engineering networks, consisting of specialized and interacting technical systems, provide supply and use of resources (water, heat and electrical energy, information and other utility systems) to the points of consumption and, if necessary, diversion of the used resources.

### **1. Supply of energy resources**

#### **1.1. Electricity**

The key issue of the development of the JINR power supply system is the reconstruction aimed at improving the reliability and supply capacity of GPP-1 and GPP-2 substations by 110kV/6kV and 110kV/10kV, respectively.

In the previous period, work has been carried out, which resulted in additional capacity for JINR: stage 1 – obtaining 7 MW in 2011; stage 2 – 28 MW after reconstruction of GPP-1 and GPP-2, as well as substation 220 kV “Tempy” in 2021–2023.

As part of the reconstruction, in addition to the increase in capacity, equipment has been upgraded – 110 kV transformers with a capacity of 40 MW, 110 kV equipment and new sections of 6 kV busbars. The reconstruction of GPP-1 allowed doubling the capacity of the substation, which made it possible to fully meet the needs of the NICA megascience project and equipment at the VBLHEP site on the whole.

As a result of the reconstruction of GPP-2, the third and fourth power transformers will be put into operation on a permanent scheme, which will make it possible to gather into a separate group all JINR facilities receiving power directly from the substation, including IBR-2 pulsed reactor, U-400 and U-400M cyclotrons, Phasotron, computing network of the Institute and its computing clusters. This will significantly reduce the number of emergency shutdowns of the facilities that occur as a result of disturbances and shutdowns in the city power networks.

The project documentation for backup power supply of sewage pumping stations of JINR CPED from autonomous generator units has been developed.

Design of backup power supply of the key consumers of DLNP, MLIT, FLNP, central boiler house and JINR CPED pump-filtering station from HPP-191 of the Moscow Canal through the CDS-12 of the city network with a total capacity of 4 MW has been performed. Implementation of these tasks is planned for 2023 - 2026.

Of equal importance is the provision of backup power supply from autonomous generators at strategic facilities of the Institute. It is necessary to provide a self-contained power supply to the telephone station and physical protection of the facility.

#### **1.2. Heat**

To date, a significant amount of work has been carried out on the replacement of worn-out heat networks at the Institute’s sites with the use of new heat insulation technologies, on the reconstruction of the Eastern

and Central boilers, on the organization of commercial accounting of heat energy. This has reduced energy consumption in heat and hot water systems and increased their reliability.

Work on the reconstruction of boiler houses and heating networks will be continued, which is also dictated by the Rostekhnadzor authorities. It is necessary to build a new modular boiler for the rest house “Ratmino” and heat networks in the planned area of housing construction “Stela”.

For a comprehensive approach to the modernization of boiler equipment and planned overhauls of heat networks of the Institute sites and the city, a target program for the period 2024-2030 with funding from the Institute’s budget and third-party sources is planned.

### **1.3. Water and sewage**

The main problem of these systems is the networks wear, namely, water network, which has been in use for more than 50 years and is outdated. It needs planned replacement with modern technological tubes.

In the previous period, a planned step-by-step replacement of the main networks on the DLNP site was carried out. In 2021, to improve the reliability of drinking water supply, mixer of the pump filtering station was replaced with a new one, stainless steel. Reconstruction of the suction water pipe lines Du 600 at the first uplift station is also required.

At the request of the supervising authorities, in order to reduce the negative impact on the environment, including the Volga River, a project has been developed for the establishment of a treatment unit for wash water at pump filtering station. It is necessary to upgrade the storm drainage on the DLNP technical site, to construct new water supply facility.

For a comprehensive approach to the modernization of the equipment and planned overhauls of the networks of the Institute sites and the city, a target program for the period 2024-2030 with funding from the Institute’s budget and third-party sources is planned.

## **2. Communication and telecommunication means**

For reliable operation of the telephone and data network, the construction and replacement of the fiber-optic line channels and local cable network at JINR and city, going to a high-level provider, are envisaged.

The JINR local area emergency alarm system, which was put into operation in 2022 and is interconnected with the city's alarm system, together with the emergency and technical center of JINR, provides alarm signals and information to the leaders and object staff, local population residing within the system local area, and other emergency services and organizations in a 5 km area of nuclear- and radiation-hazardous objects.

It is planned to implement a unified JINR CCTV system as well as to develop an automated system of data collection, control and dispatch of energy and utilities resources, which already includes more than 500 accounting blocks.

Plans for 2024-2030 also include the task of creating a geographic information system of the Institute, comprising up-to-date information of all external networks and digital twins of the Institute’s infrastructure facilities.

### **3. Security Policy**

#### **3.1. Labor protection, industrial safety, environmental protection**

To solve problems related to labor protection, environmental protection and industrial safety, work will be carried out on a special assessment of the working conditions of employees, certification and advanced training of JINR managers and specialists, replacement of morally obsolete and physically worn out equipment, as well as modernization of the testing industrial and sanitary laboratory. In addition, a unified system of production waste delivery (including hazard classes 1 and 2) will be introduced, including payments for negative environmental impact.

#### **3.2. Radiation and nuclear safety**

The Institute implements an optimal policy to minimize the radiation impact on humans and the environment by improving the safety of existing and designed nuclear physics facilities, ensuring safety and security in the handling of nuclear materials, radioactive substances, radiation sources and radioactive waste.

The main tasks for 2024–2030 are:

- improvement of the system of personal radiation monitoring, its adaptation to the real radiation fields of nuclear physics facilities by adjusting the correction factors;
- operation and modernization of automated radiation monitoring systems (ARMS) of operating facilities and the central repository, development of new systems at newly built and reconstructed radiation-hazardous JINR facilities, development of tools for monitoring high-energy neutrons, replacement of obsolete instrumentation;
- extended operation of the storage facility of nuclear materials and radioactive substances, including maintenance of the elements of the material accounting and control system using a computerized database system by a separate control and methodological group;
- timely shipment for burial of radioactive waste, sources with expired designated service life, prevention of their accumulation;
- accreditation of the metrological service and radiation control laboratory, certification of measuring and control instruments, metrological support of radiation control instruments, including with the involvement of metrological centers;
- creation and maintenance of a quality management system for nuclear facilities, development of internal local regulatory documents and procedures in accordance with the requirements of federal norms and rules in the field of atomic energy use;
- participation in the work carried out within the framework of the agreement between JINR and FMBA;
- Obtaining a permit from Rostekhnadzor for the release of radioactive substances into the atmosphere.

#### **3.3. Licensable activities in using nuclear energy**

As part of ensuring the licensed activities of JINR in using nuclear energy, licenses from Rostekhnadzor for the operation of a nuclear facility (IBR-2), for the operation of a stationary facility for the storage of solid radioactive waste and nuclear materials, for the use of nuclear materials and radioactive substances in R&D, for the right to operate radiation sources, as well as a license from Rospotrebnadzor to carry out activities in using ionizing radiation (generating) sources.

### **3.4. Fire safety**

It is planned to gradually reconstruct the existing automatic fire alarm and fire- extinguishing systems, and also, due to the development of the Institute’s experimental basis, to put into operation new modern systems, involving specialists from the JINR fire automatics section.

The inspections at the Institute show that its buildings and structures in many respects need to be modernized in accordance with fire safety standards. Within the framework of the system approach, it is planned to develop an updated target program “Ensuring JINR fire safety for 2024–2030.

### **4. Capital construction**

In addition to modernization of the operating engineering infrastructure of the Institute, it is necessary to create and reconstruct the complexes: security systems and checkpoints of technical sites, rest house “Ratmino”, resort hotel “Dubna”, tourist base “Lipnya”, facilities of SIMand HRCM Offices, as well as objects in a planned area of housing construction “Stela”.

## INNOVATION ACTIVITIES

The strategic goal of the innovative development of JINR for the period up to 2030 is to make the Institute the leading center for the transfer of knowledge of the JINR Member States in the field of nuclear physics and accelerators. The Institute's innovative activities are intended to stimulate their interest in the expansion of the program of applied research at JINR basic facilities, contribute to the development of research infrastructure in the JINR Member States.

Implementation of innovation plans for the period 2024–2030 assumes concentration of efforts in the following main directions.

### **Development of the international innovation center for nuclear physics research**

The main goal of organizing the JINR Interlaboratory Innovation Center (hereinafter referred to as the Innovation Center) is the coordination of applied and innovation research in the most demanded radiation, biomedical technologies, including in particular the development of technologies and methods in the field of nuclear, radiation and space medicine, radiation materials science, ecology and information systems, as well as personnel training and professional development of specialists from the JINR Member States under the programs of the basic departments of partner universities. Coordination of the activities of the Innovation Center will be carried out both through the use of common approaches and expertise of the International Advisory Committee to the formation of a competitive scientific programme and to the planning/use of beam time, and by measures to improve the organizational structure.

The main stages of the implementation of the project for the creation of the Innovation Center are:

- applied innovative research within the framework of the project of a complex of superconducting rings on colliding beams of heavy ions NICA, including the creation of research infrastructure ARIADNA (**A**ppplied **R**esearch **I**nfrastructure for **A**dvanced **D**evelopments at **NICA** **f**acility) based on three specialized research channels: (1) heavy charged high-energy particles (150–350 MeV/nucleon for research on the radiation resistance of semiconductor micro- and nano-electronics and 500–1000 MeV/nucleon for life science research; (2) low-energy heavy charged particles with an energy of 3.2 MeV/nucleon for testing the radiation resistance of micro- and nano-electronics; (3) beams of protons, deuterons and light ions with energies of 1.0–4.5 GeV/nucleon for obtaining new nuclear data and advanced developments for nuclear power technologies, transmutation of spent nuclear fuel, creation of new neutron sources (implementation period: 2024–2027);
- support of ARIADNA collaborations and development of user program of the channels for applied research at the NICA complex (implementation period: 2024–2030);
- development at the Veksler and Baldin Laboratory of High Energy Physics of high-temperature superconductivity technologies, first of all, for the creation of electromagnets of accelerators and inductive energy storage;
- establishment at the Flerov Laboratory of Nuclear Reactions of the DC-140 accelerator complex for research in the field of radiation materials science, tests for radiation resistance of electronic components, improvement of the technology for the production of track membranes, etc. (implementation deadline: 2024);
- establishment at the Flerov Laboratory of Nuclear Reactions of a modern radiochemical complex, including a class I radiochemical laboratory, with the aim of developing new radioisotopes for nuclear medicine in photonuclear reactions at an industrial electron accelerator (implementation period: 2024–2026);

– establishment of a center for research and development in the field of radiation therapy: research on proton flash therapy, development of new approaches to treatment planning; pencil beam technologies, creation at the Dzheleпов Laboratory of Nuclear Problems of a superconducting proton cyclotron (230 MeV) as a pilot facility for a future medical center (implementation deadline: 2024);

– radiation biology: expansion of the research infrastructure of the Laboratory of Radiation Biology, development of OMICS technologies, neuroradiobiological research, development of approaches to improve the effectiveness of radiation therapy based on radiomodifiers (pharmaceuticals, transgenic systems), search for new methods of targeted delivery (molecular vectors) of radiomodifiers and radionuclides to tumor cells.

The Innovation Center program will also include medium-term interlaboratory projects that imply the expansion of the experimental research program, as a place for the development of new technologies and a testing ground for advanced scientific research (Open Research Space @ DUBNA) in the following areas: life sciences, technologies of environmentally friendly carbon-free energy, big data and quantum computing. The key part of the agenda of the Innovation Center will be the development of applied segment of the user program at research reactor IBR-2M as well as studies in the field of artificial intelligence and quantum computing technologies carried out on the basis of the Meshcheryakov Laboratory of Information Technologies and the Veksler and Baldin Laboratory of High Energy Physics, R&D on linear superconducting continuous accelerators; micropixel detectors of the Medipix family, new avalanche photodetectors, laser metrology, laser inclinometers, etc.

The implementation of innovative projects based on the research infrastructure of the Innovation Center should become a significant additional incentive to expand the interest and involvement of the JINR Member States and associate members in the JINR research program. The priority area for the development of the Innovation Center should be to provide opportunities for young professionals and students from the Member States to carry out cutting-edge innovative research.

### **Integration into the global innovation system**

One of the important tasks of the current seven-year period is the effective integration of JINR into the global innovation system and into the global scientific information system. In this direction, the Institute plans to carry out activities on the following main tasks.

1. Development of partnership in the field of innovation with organizations of the JINR Member States and other countries.
2. Formation of the leading positions of JINR in expert scientific and innovation communities and committees of interstate integration associations.
3. Conducting field events in the JINR Member States in order to promote the innovative capabilities of the Institute and form communication channels in the field of innovation.
4. Organization of internships at JINR and innovation centers on the territory of the Russian Federation for students and young employees of research, educational and innovative organizations from the JINR Member States.
5. Participation in international exhibitions, conferences, forums of an innovative nature.

In order to create a system for processing business requests for custom R&D based on the expertise and research infrastructure of the Institute, it is planned to expand interaction with companies-residents of the special economic zone of the technology-innovative type “Dubna” and other organizations, as well as launching ways of attracting industrial partners to JINR.



Specific activities and deadlines for completing the tasks of this section of the program for 2024–2030 will be updated annually in the plans of JINR innovation activities.

### **Implementation of the intellectual property policy, organizational and information support of JINR's innovative activities**

Particular attention will be paid to the consistent implementation of the JINR intellectual property policy. Improving the interaction of the Institute's departments and services at all stages of the life cycle of the results of intellectual activity (RIA) is aimed at ensuring their timely identification, protection, accounting, and efficient use.

Measures will be worked out for additional incentives for the activities of JINR employees in the creation of RIA, which have a significant potential in terms of use in the Institute's activities and technology transfer. In order to further support the development of the most promising innovative areas, the issue of establishing a grant from the Directorate, a competition for innovative projects, and the JINR Innovation Development Fund is being considered.

The interaction between the existing and emerging subjects of innovation in the laboratories and at the Institute level, including innovative development departments and groups, will be improved.

In view of the importance of wide coverage of JINR innovation activities, the priorities should be:

- creation, professional content and promotion of the site on JINR innovative research;
- introduction of best practices for promoting innovation, cooperation and use of the experience of technology transfer groups of other organizations;
- PR of JINR innovation activities, including the preparation and publication of popular science articles, digests about the Institute's promising developments, building the image of JINR through coverage of JINR's innovative developments in central and regional media;
- participation in international exhibitions, conferences, innovation forums;
- participation in JINR off-site activities in the Member States with a view of presenting the innovative potential of the Institute.

## **STRENGTHENING HUMAN RESOURCES**

For the successful implementation of the scientific programme of the Institute and the fulfillment of its mission to train highly qualified researchers, engineers and technicians for the Member States, JINR conducts a carefully balanced scientific and educational activity both in scientific areas and in professional competencies. During the planned period, this activity will be continued along with a number of measures of the Institute's personnel policy aimed at strengthening the intellectual potential of the Institute's employees without a significant increase in the number of the Institute's staff. Formation of numerous associate personnel in “dynamic balance” with the staff, cooperation with the basic departments of partner universities, the Dubna branch of Moscow State University, MEPhI, MIPT, St. Petersburg State University, Kazan (Volga Region) Federal University and the State University “Dubna” as flagship universities, the scientific and educational programme of the JINR UC, popularization of science and scientific activities of JINR, and the proactive social and personnel policy of the Institute are important interrelated elements of work to be undertaken.

### **Scientific and Educational Activities**

The Institute has extensive experience and potential in the field of training highly qualified specialists for the JINR Member States. The organization of scientific and educational activities and training of personnel is the main task of the JINR University Centre. To implement this mission, over the next seven years, the UC, in cooperation with the Laboratories of the Institute, will work in the following areas.

The first priority of the UC remains the delivery of a high-quality service to the students and postgraduates from the JINR Member States who arrive to the Institute's Laboratories to prepare their qualification papers: BSc, MSc and PhD theses. The UC helps students find supervisors and provides support in organizing their arrival and stay at JINR. The UC coordinates the work of the basic departments of partner universities at the Institute, participates in network educational programmes, in particular, organizes special courses of lectures and practice in accordance with the curricula of partner educational organizations. Effective work in this direction will be carried out in cooperation with schools, universities and research centres of the JINR Member States.

JINR has six Dissertation Councils for the defense of PhD and doctoral theses. The UC will work to attract graduate students and young scientists from partner scientific and educational institutions to defend their PhD theses in the Dissertation Councils of the Institute.

An important task of the UC will be the organization of educational programmes for students. They include both short-term (International Student Practice) and long-term programmes for undergraduate and graduate students, namely, a full-time START student programme and INTEREST online training for participants from all over the world. The purpose of these events is to acquaint students with the Institute, to provide them with an opportunity to take part in the daily work of research groups in the JINR Laboratories, to immerse themselves in the scientific life of the Institute, to establish contacts with other students and postgraduates, to adjust their scientific interests, and to find scientific supervisors at JINR to carry out their qualifying papers.

In order to intensify educational programmes in the field of training of engineering and technical specialists for JINR and the Member States, at the existing modern physical facilities and at those under construction, the UC has developed an engineering workshop, the key feature of which is work with real equipment. In particular, workshops on electronics, basics of nuclear physics and elementary particle detectors, microwave and vacuum technology, and automation of physical installations were created. This work will be continued,

new courses will be developed, and the instrument base will be timely updated. In particular, an important task is to develop practical training courses at dedicated channels of the linear electron accelerator at DLNP. This will allow students and young researches to deepen their existing knowledge and acquire new skills, and to gain personal practical experience in using modern equipment and technologies.

The outreach programmes of JINR aimed at schoolchildren, students and teachers from the Member States are an important part of the UC activities to increase interest in natural science subjects. Currently, the UC has the following tools for working with schoolchildren: online and offline lectures by the Institute's staff, excursions to the JINR basic facilities, virtual laboratories in experimental nuclear physics. The UC supervises the work of the City Interschool Physics and Mathematics Faculty, participates in the project activities of students of the Physics and Mathematics Lyceum named after Academician V.G. Kadyshevsky. The UC organizes the participation of the Institute in city, regional, federal popular science events. Every year the UC holds an International Scientific School for Teachers of Physics from the JINR Member States. The Center also participates in the university career forums in order to attract students to work at the Institute. Various events aimed at facilitating the understanding of modern physics, as well as highlights of the main scientific achievements of JINR and attraction of interested students, will remain a priority task for the UC in the upcoming period of work.

The commissioning of the DLNP linear accelerator will allow the University Centre to extend its work with schools and organize an international competition among high school students to select proposals for solving scientific problems. The winning team will have a unique opportunity to conduct their experiment at a real JINR facility.

Strategic cooperation with the Branch of the Lomonosov Moscow State University opened in Dubna in 2021 will be continued. The following departments are planned to be formed stage by stage at the Branch: Department of Elementary Particle Physics, Department of Fundamental Nuclear Physics, Department of Fundamental Mathematics and Mathematical Physics, Department of Theoretical Physics of Fundamental Interactions, Department of Networking and Supercomputing Technologies and Modeling, Department of Radiobiology and Biomedicine. The total number of students and postgraduates of the Dubna Branch can be from 80 to 160 people.

It is of great importance for JINR to develop Dubna State University as a research technological university that trains highly qualified research engineers for participation in projects of "mega-science" class. Due to the deep integration of JINR into international research projects, the capabilities of universities and scientific centers of other countries (primarily those of the JINR Member States) can be used in the personnel training by implementing network educational programmes and internships/practices.

For employees of the Institute and other organizations, the UC provides additional professional training. For JINR personnel, the UC also organized courses in English and in Russian as a foreign language.

### **Personnel and Social Policy**

The personnel policy will be focused on providing the Institute with staff capable of successfully fulfilling the next Seven-Year Plan for the Development of JINR at a high world level. The status of an international intergovernmental organization implies a high level of global competition for human capital. To achieve this goal, constant efforts are needed to attract highly qualified specialists and scientists from the Member States and JINR partner organizations. Interesting creative work, worthy remuneration of labour and a comfortable environment are the three main components of social and professional satisfaction of the staff, which should be given increased attention by receiving feedback through surveys, interaction with the leaders of national groups, etc., flexibly setting up existing and creating new personnel work tools.

In the new seven-year period, the focus of the Institute's development is shifting from the creation of large-scale research facilities (primarily the NICA accelerator complex) to the development and implementation of scientific research programmes using these facilities. The staff who participated in the design, development of systems of new basic facilities, construction, installation, and adjustment of equipment should be replaced by personnel who will ensure the reliable and safe operation of these complicated unique complexes, the implementation of extensive experimental research programmes. Engineering and technical workers, specialists of other functional purposes will be required. The number of researchers who will be engaged in the collection, processing, analysis, interpretation of the results of experiments and the implementation of the scientific agenda will be increased. It is planned to create conditions for advanced training, as well as training and retraining of personnel, to take measures to introduce and improve the institution of mentoring. Constant work is needed to ensure the training and personnel professional and intellectual development using the best latest methods and formats in this area.

In addition to qualitative and minor quantitative changes in the main Institute's staff, a multiple increase (up to 1000 people by 2030) of associated personnel is expected – employees of research or scientific and educational organizations, students and postgraduates of universities sent to JINR for long-term (3 months and more) residence for work in joint projects, including within the framework of collaborations and user programmes. For the regulation of activities aimed at the development of the institution of associate staff members, in 2021, the Regulations on Associated Staff were approved. The task for the coming period is to improve this multi-purpose instrument of personnel policy in order to ensure a high level of research intensity at the Institute's facilities, to fulfill the mission of JINR as an international intergovernmental organization on creating conditions for joint research by scientific organizations of the Member States and optimizing the system of personnel training in the interests of the Member States and JINR partners.

Successful implementation of the new Seven-Year Plan is impossible without an influx of young personnel, without ensuring the continuity of generations and transferring the accumulated knowledge and rich traditions of the Institute's scientific schools. Attraction and integration of young people from the Member States and JINR partners into teams, their professional development and opportunities for career growth – one of the main tasks of personnel policy. It is planned to develop existing and introduce new social programmes aimed at improving the quality of life and working conditions of young employees. It is also planned to further apply and expand the system of grants and awards for young scientists and specialists, support young researchers without a degree by means of personal salary increments. In order to create modern comfortable living conditions, money resources will be allocated to increase the service housing fund and improve its quality, to compensate for the payment for rented housing.

The scholarship Programme for young scientists will be further developed as part of a special international competition with the support of the commissions with JINR Member States.

Caring for veterans, whose many years of work created the modern image of JINR, its authority in the world scientific community, is one of the important tasks of personnel policy. Based on the relevant decisions of the CP sessions, the Institute approved since July 2022 the Regulations on social support for persons who have terminated employment relations with JINR. The developed social support programme stimulates the retirement of elderly personnel with long work experience at the Institute, giving way for younger employees, while at the same time preserving the opportunity for veterans to participate in scientific and cultural events of the Institute, who thereby make a feasible contribution to the professional development of young people. The measure is aimed at creating a structure and model of personnel reproduction that is optimal for the successful implementation of the research programme and infrastructure projects within the framework of the Seven-Year Plan.

In the previous seven-year period, a significant salary reserve was created. Since 2021, by decision of the CP, a fund for stimulating highly qualified personnel has been formed and is planned annually in the budget of the Institute. The funds are directed to support staff engaged in the main projects of the Institute, to special development programmes and attraction of young talented specialists and scientists, lump-sum payments for successful defense of dissertations, incentive increments, awards to teams for special achievements in the implementation of large-scale projects of the Institute. Thanks to measures to improve the remuneration system, the average monthly salary of researchers, the main category of personnel, has reached 200% of the average monthly salary in the region of Institute’s location, which is a necessary condition for competitiveness in the country of residence. However, the competition for talents on the world stage requires internationally competitive salaries. This task has to be solved by paying constant attention to the study of international experience, changes in the legislation of the state of residence, the use of best practices and developments.

In order to maintain the real content of salaries in the face of rising consumer prices, it is planned to extend the experience of annual indexation of the salary (tariff) part of wages for a new seven-year period.

**Table 9.** Personnel forecast by categories (FTEs quantity) and staff costs (Articles 1-3 of the JINR budget, thousand US dollars)

	<b>2022</b>	<b>2024</b>	<b>2030</b>
<b>JINR personnel,</b>	<b>4060</b>	<b>4090</b>	<b>4230</b>
<b>including:</b>			
Researchers	1190	1200	1240
Engineers	1020	1030	1070
Managers, specialists, and employees	1100	1110	1160
Workers	730	750	760
<b>Associate personnel</b>	150	400	1000
<b>TOTAL:</b>	<b>4210</b>	<b>4490</b>	<b>5230</b>

## ORGANIZATION OF SCIENTIFIC ACTIVITY

The successful implementation of the research program presented in the JINR Development Strategy requires the modernization of the Institute's scientific and organizational activities as a key factor affecting all aspects of JINR functioning, including the personnel and financial policy, administrative and economic activities, international cooperation, etc. The document defining the organizational basis for effective scientific activity in JINR is the annually updated Topical Plan for JINR Research and International Cooperation. The Topical Plan (TP) should be balanced and provided with financial and human resources available to the Institute. Regular scientific and resource analysis of the implementation of TP should be provided by the organization of independent expertise and effective synchronization of the work of the Science and Technology Councils at the Institute, international program advisory and other specialized scientific committees, commissions on project implementation analysis, the JINR Scientific Council.

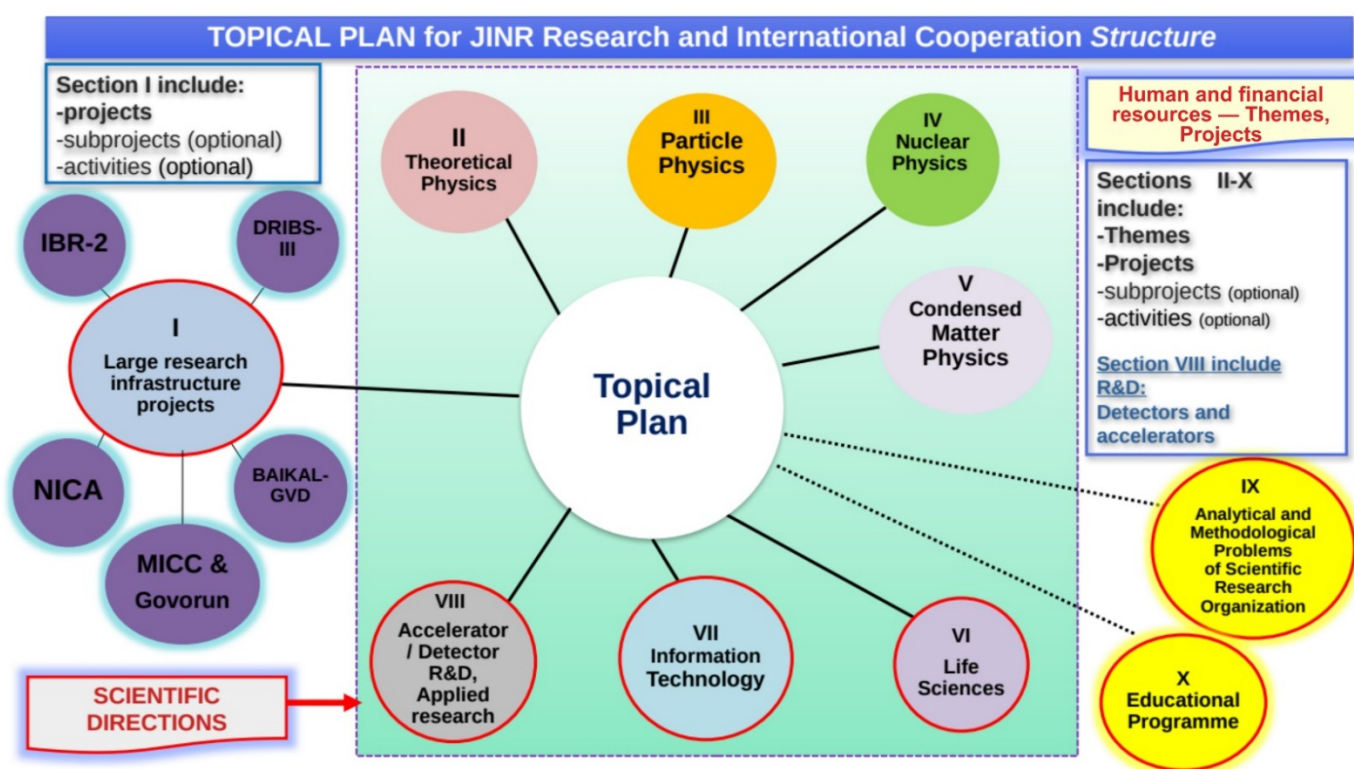

**Fig. 35.** Planned updating of the structure of the Topical Plan for JINR Research and International Cooperation

The expansion of the Institute's research program, the increased dynamics of the emergence of new scientific directions, intensified competition for leadership in shaping the global research agenda, as well as a significant increase in international staff mobility, require correction of the TP structure and procedures related to its content and implementation.

## **DEVELOPMENT OF JINR AS AN INTERNATIONAL SCIENTIFIC ORGANIZATION**

In view of the status of JINR as an international intergovernmental organization, internationality is inherent in all JINR activities. In this document, the term "JINR international cooperation" refers to the activities of the Institute for the organization and coordination of the full range of external relations and interaction of all participants in multilateral cooperation, implemented within the framework of JINR, aimed at:

- ensuring the sustainable development of the Institute as an international intergovernmental organization by maintaining its organizational basis – the community of member states, associated countries, national partners from other countries, international organizations, as well as its expansion by attracting new partners;
- assistance in the implementation of the main statutory task of JINR – the organization and implementation of multilateral scientific research, as well as the creation of prerequisites for the emergence of new projects and areas of scientific cooperation;
- assistance in promoting favorable regulatory, financial and economic conditions for the participation of scientific organizations of the JINR partner network in the implementation of the JINR research program;
- promoting the mobility of scientific and engineering personnel, the creation of favorable social and economic conditions at JINR for the work of scientists and specialists from different countries;
- strengthening of JINR's international authority and popularization of its scientific achievements.

During 2024–2030, a set of medium-term tasks of the practical implementation of JINR international cooperation will be solved, specified by the status of countries in the JINR partner network, the level of scientific and technological development, geographical location, as well as resources and tools used in the development of cooperation.

In particular, according to the status of countries in the partner network, these tasks are specified as follows:

–**Member States:** to adhere to an individual approach to strategic planning of relations with each Member State; to provide the necessary conditions for optimizing the process of full-scale inclusion of a new Member State, the Arab Republic of Egypt, in the activities of the Institute; to establish coordination committees for cooperation with the participation of Plenipotentiaries of Governments and interested national experts, as well as representatives of JINR; in particular, in the near future, to provide for the establishment of these committees with Azerbaijan, Kazakhstan, Mongolia, Uzbekistan and the reformatting of the committee with the ARE in the context of raising the level of participation of the ARE in JINR; to prepare proposals for updating the agreement on the conditions of JINR's residence in the territory of the Russian Federation;

–**Associate Member States:** to continue work on organizing Serbia's entry into JINR as a full member, to attract new countries to JINR as associate states, guided by the "Regulations on Associate Membership in JINR";

–**Other countries:** to further deepen the existing cooperation with individual scientific organizations and to involve new interested partners in the orbit of JINR scientific cooperation, including from Latin America (Argentina, Brazil, Chile, Mexico), Asia (China, India, Pakistan, South Korea, Turkey, ASEAN countries), Africa (Botswana, Tunisia, countries of the East Africa region).

The **regionalization of JINR's international activities**, i.e., the creation of regional network structures on the basis of JINR Member States and Associate Members to unite countries interested in developing

scientific ties with the Institute, will continue. In this context, it is necessary to intensify regular, purposeful work with the Member States and Associate Members on the basis of which these clusters are planned to be created, in particular, with Cuba for the Latin America cluster, with Vietnam for Southeast Asia, with RSA for South Africa, and with Egypt for the Middle East and North Africa.

To provide existing and planned tasks with resources, the work of the Institute's specialized services in the field of ISTC, as well as the relevant functional groups in the subdivisions, should be effectively organized: clear planning, diversification, complementarity, optimal staffing structure and involvement of representatives of the Member States, reliance on scientific and educational cooperation and priorities of the JINR Topical Plan.

### **The program of measures for the development of JINR as an international intergovernmental scientific organization**

In the period 2024–2030, the most effective way to strengthen the Institute's institutional links with Member States and partner organizations is to use the following existing or currently being created **instruments** of JINR international cooperation:

- formation at JINR of professional communities of national representatives to coordinate cooperation between Member States in special thematic areas: industrial cooperation, industrial return and innovation (Industrial Liaison Officer), education (Education Liaison Officer);
- development of a network of JINR information centers;
- annual trainings within the framework of the target information program for scientific and administrative staff of partner organizations (JEMS trainings) on the basis of an open invitation and/or at special requests from individual countries;
- continuing the practice of holding “JINR Days” in the Member States and Associate Members, on average once every five years, as well as “Country Days at JINR”;
- implementation targeted internship programs (up to 30 positions per year) at JINR for young scientists from the countries of JINR target regions of Latin America, Africa and Asia, as well as under the UNESCO internship program. The starting number of internships in 2024 is planned to be 15 positions, and the program will reach its full capacity in 2027.



## DEVELOPMENT OF SCIENTIFIC COMMUNICATION

The priority of the JINR Communication Strategy is the development of favourable conditions in the target segments of the information space for the implementation of the JINR Long-Term Development Strategic Plan up to 2030 and Beyond.

The implementation of the Communication Strategy is designed to ensure effective outreach and pragmatic interaction with key audiences: specialized scientific community; decision makers; students, teachers, schoolchildren; general public of the Member States and partner countries; local community (city, region); employees of the Institute, people within the JINR orbit.

Formation of a system of basic messages of the Communication Strategy, construction and proactive use of a system of targeted communication channels based on the analysis of the target audience's profile in the information space, assessment of risks and communication results will ensure the solution of the following tasks in the context of target audience segments:

1. Specialized scientific community

Development at JINR of a unique environment for exchange of scientific knowledge and cooperation of researchers from all over the world.

2. Decision makers

Targeted information support for decision makers on the JINR agenda. Information support for attracting new partner countries and developing cooperation with industrial partners.

3. Students, teachers, schoolchildren

Accompanying the development of a partner network of target universities and schools, replenishment of the Institute's personnel reserve from partner countries, strengthening the community of "ambassadors" of JINR. Popularization of science, increasing the reputational significance of the profession of a researcher.

4. General public of the Member States and partner countries

Raising the level of awareness about the significance of the scientific agenda results, JINR's initiatives and advantages of a country's participation in JINR for its society and economy. Increasing the level of the target audience's loyalty.

5. Local community (city, region)

Promotion of the slogan "Dubna – the city of international science". Presenting the significance of the international character of JINR, its role as an effective city-forming enterprise, attractive employer and scientific and technological partner.

6. Employees of the Institute, people within the JINR orbit

Strengthening and dissemination of the values and high corporate culture of JINR. Assistance in increasing the employees' satisfaction and motivation. Intensification of horizontal links between divisions and communications within the JINR orbit. Support for the development of the mentoring institute and the community of "ambassadors" of JINR.

The implementation of the Communication Strategy involves the coordination of the activities of JINR specialized subdivisions, as well as JINR Information Centres, consistent formation of unified methodological approaches and an effective structure of work organization in the field of strategic communications, and also the implementation of measures in the following areas:

– Public relations and scientific communication (development of a digital communication platform with a built-in hierarchy of Internet resources; press-tours for the mass media; "Do Science @ Dubna" information campaign, scientific exhibition complex "JINR: Science and Education", scientific tourism at JINR, exhibition site "Art&Science").

– Formation and development of an information support system for decision makers and subjects relevant for the implementation of JINR initiatives (support for interaction with government authorities of partner

countries, updating, implementation and promotion of the Institute's corporate identity, development of targeting tools, creation of an electronic platform for protocol services).

- Development of science diplomacy tools, initiating science diplomacy and science popularization projects.

## **DIGITALIZATION OF ADMINISTRATIVE AND MANAGEMENT ACTIVITIES**

The main task of the Digital Services Development Department (DSDD) within the framework of the Seven-Year Plan for the Development of JINR for 2024–2030 is to create an all-Institute information infrastructure for administrative and managerial processes.

DSDD shall develop information services aimed at the digital transformation of the Institute's administrative activities, as well as at creating a platform for combining digital services related to administrative processes. The key project in the medium term is the one to implement the integrated information system 1C:ERP.

## DEVELOPMENT OF SOCIAL INFRASTRUCTURE

The social infrastructure of the Institute performs the task of providing the employees with accommodation, catering services, including therapeutic and preventive nutrition, physical training and sports, organization of sanatorium treatment and cultural leisure activities. The social infrastructure facilities available at JINR provide all the aforementioned services to the staff of the Institute. At the same time, many of these facilities require modernization and expansion of current repair and, in some cases, overhaul. The JINR scientific programme for 2024–2030 and the personnel policy resulting from it require continuous improvement of socio-economic conditions of work and life of the JINR staff and their families, which cannot be provided without implementing a set of measures to improve the Institute's social infrastructure in cooperation with relevant organizations and departments of Dubna, the Moscow Region and the Russian Federation as the JINR host country.

Over the next few years, the emphasis in JINR's work will shift to the implementation of large-scale research programs using the research infrastructure facilities created in the previous period. To attract the highly qualified scientists and specialists from the Member States necessary for this task, the following set of measures is required:

- Expansion of the housing stock,
- Repair and modernization of a number of social infrastructure facilities,
- Creation of new facilities.

Budgetary possibilities of JINR and the priority of the scientific programme of the JINR Development Plan for 2024–2030 make it expedient to attract external resources in the form of Public-Private Partnership (hereinafter referred to as PPP), allowing participation of the international intergovernmental organization - JINR, and similar financial and economic mechanisms of involvement of private business and/or development institutions of JINR Member States for creation and/or development of large objects of social infrastructure.

A comfortable living environment is one of the main components of social satisfaction of the staff, and for its creation it is necessary to provide appropriate resources in the financial plan of the JINR Seven-Year Development Programme for the following directions:

### **1. Expansion of the housing stock (apartments, hostels, hotels)**

1.1. Acquisition (or construction) of 50 apartments annually for the Institute's service housing stock to update the apartments in use and to conduct ongoing work to develop a structure and quality of personnel optimal for the successful implementation of the research programme and infrastructure projects under the Seven-Year Plan.

1.2. Re-profiling the Ratmino Recreation Center into a complex of apartments for temporary accommodation of scientists and specialists with appropriate development of the accompanying infrastructure (based on the campus principle). The need for such a complex is justified by the plans of a significant quantitative growth (up to 1000 people by 2030) of the associated personnel - employees of JINR partner scientific or educational organizations who are sent by these organizations for three or more months to perform work on joint projects with JINR.

### **2. Modernization of a number of social infrastructure facilities in order to bring them up to modern requirements**

#### **Catering Facilities**

2.1. Overhaul and replacement of technological equipment of the canteen at the VBLHEP site, as well as the restaurant "Dubna", which will increase the capacity and improve the quality of service for the increased number of personnel coming to conduct experiments on the NICA collider.

2.2. Taking into account the specifics of round-the-clock work of researchers in the new seven-year period, it is advisable to take measures to expand the buffet service and develop a network of cafeterias.

### **Facilities of the JINR Sports Complex and Cultural Objects**

2.3. Major repairs of buildings, structures, and technological equipment of the swimming pool "Arkhimed", stadium "Nauka", House of Physical Education, House of Culture "Mir", the Blokhintsev Universal Library, tennis courts, and the JINR Yacht Club in order to bring their condition in line with modern requirements, increase the attractiveness of the facilities, expand the circle of visitors, and develop club activities.

### **Recreation and Health Resort Treatment Facilities**

2.4. Implementation of measures as part of the development strategy of the Dubna resort in Alushta, Republic of Crimea, aimed at creating conditions for prolonging its work in the off-season, holding scientific conferences and developing medical services.

2.5. Expansion and renovation of the infrastructure of the recreation centers "Volga" and "Lipnya".

### **3. Initiation of the creation of social infrastructure objects of municipal or private property on the territory of Dubna**

3.1. Expocentre — Museum of Science and Technology. Creation of a modern museum of science and technology with a view to popularizing science and JINR. It is to be implemented through PPP mechanisms.

3.2. Science and technology children's recreational camp. Initiation of the creation of a science and technology children's recreational camp near the city with the aim of expanding opportunities for children of JINR employees and city residents to organize summer recreation. It is to be implemented through a PPP project or entirely by private investors. JINR will contribute to the creation of this children's camp.

3.3. Bilingual kindergarten. Initiation of the creation of a kindergarten with bilingual education with the aim of offering non-Russian-speaking children an opportunity to receive preschool education. It is to be implemented through a PPP project or entirely by private investors, and is not planned to be included in the infrastructure of the Institute.

3.4. Urban environment. Improvement of the quality of the urban environment. Saturation of the urban environment with objects that popularize science, as well as with "art" objects of scientific and technological orientation, in order to maintain the science city environment. It is to be implemented by the Dubna City Administration through the participation in the state urban development programs.

## FINANCIAL SUPPORT

**Table 10. Budget Revenue Structure**

(USD million)

	<b>2024</b>	<b>2025</b>	<b>2026</b>	<b>2027</b>	<b>2028</b>	<b>2029</b>	<b>2030</b>	<b>TOTAL</b>
Member States' contributions	207,3	218,7	230,7	249,1	261,6	274,7	288,4	<b>1 730,5</b>
Payment of arrears of Member States' contributions	0,1	0,1	0,1	0,1	0,1	0,1	0,1	<b>0,7</b>
Funds received under scientific and technical cooperation agreements	2,5	2,5	2,5	2,5	2,5	2,5	2,5	<b>17,5</b>
Other revenues	6,0	6,0	6,0	6,0	6,0	6,0	6,0	<b>42,0</b>
<b>TOTAL</b>	<b>215,9</b>	<b>227,3</b>	<b>239,3</b>	<b>257,7</b>	<b>270,2</b>	<b>283,3</b>	<b>297,0</b>	<b>1 790,7</b>

The JINR budget revenues are mainly derived from the Member States' contributions. The contributions of Member States are planned to increase by 5% each year. This will allow JINR to continue developing its experimental base, carry out a wide range of promising scientific research, develop its engineering infrastructure and attract highly qualified scientists and specialists.

The budget revenues also include the payment of restructured contribution arrears of Member States, the receipt of funds under agreements on scientific and technical cooperation with non-Member States, and other revenues.

**Table 11. Budget Cost Structure**

(USD million)

	<b>2024</b>	<b>2025</b>	<b>2026</b>	<b>2027</b>	<b>2028</b>	<b>2029</b>	<b>2030</b>	<b>TOTAL</b>
Personnel	107,6	109,1	112,8	116,6	120,5	124,6	128,8	<b>820,0</b>
Material costs for scientific activities	97,2	94,5	89,7	90,3	92,7	94,4	76,0	<b>634,8</b>
<i>Projects and activities</i>	80,7	77,3	69,9	64,3	64,7	66,3	63,3	<b>486,5</b>
<i>Maintaining and ensuring the operation of facilities (including electricity)</i>	16,5	17,2	19,8	26,0	28,0	28,1	12,7	<b>148,3</b>
Material infrastructure costs	31,9	32,9	38,0	35,8	32,5	32,4	33,3	<b>236,8</b>
<i>Modernization of engineering and social infrastructure</i>	9,9	10,1	14,7	11,2	6,7	6,7	7,2	<b>66,5</b>
<i>Repair of buildings and structures</i>	10,3	10,8	10,8	11,3	11,8	11,3	11,3	<b>77,6</b>
<i>Power and water</i>	5,4	5,8	6,2	6,9	7,6	7,9	8,3	<b>48,1</b>
<i>Administrative costs</i>	6,3	6,2	6,3	6,4	6,4	6,5	6,5	<b>44,6</b>
International cooperation	5,5	5,8	6,0	6,5	6,8	7,2	7,5	<b>45,3</b>
Service costs	12,2	12,2	12,2	12,2	12,2	12,2	12,2	<b>85,4</b>
<b>TOTAL</b>	<b>254,4</b>	<b>254,5</b>	<b>258,7</b>	<b>261,4</b>	<b>264,7</b>	<b>270,8</b>	<b>257,8</b>	<b>1 822,3</b>

Reserve for joint projects with non-participant countries	2,5	2,5	2,5	2,5	2,5	2,5	2,5	<b>17,5</b>
Reserve for Plenipotentiaries' grants, cooperation programs	2,0	2,0	2,0	2,0	2,0	2,0	2,0	<b>14,0</b>
Reserve for JINR Directorate grants	10,4	10,9	11,5	12,5	13,1	13,7	14,4	<b>86,5</b>
<b>TOTAL</b>	<b>269,3</b>	<b>269,9</b>	<b>274,7</b>	<b>278,4</b>	<b>282,3</b>	<b>289,0</b>	<b>276,7</b>	<b>1 940,3</b>
<b>BALANCE</b>								
Annual balance	-53,4	-42,6	-35,4	-20,7	-12,1	-5,7	20,3	
<b>Cumulative balance</b>	<b>-53,4</b>	<b>-96,0</b>	<b>-131,4</b>	<b>-152,1</b>	<b>-164,2</b>	<b>-169,9</b>	<b>-149,6</b>	

The outcome of the implementation of the Seven-Year Plan for the Development of JINR for 2017–2023 should be the completion of the first stage in the creation of new and modernization of existing experimental physics facilities at JINR for the implementation of new promising scientific research programs at the forefront of modern physics. By 2024, the basic configuration of the NICA accelerator complex will be created, the DRIBs-III cyclotron complex will be modernized, the Baikal-GVD deep-water neutrino telescope with a volume of 0.5 km<sup>3</sup> will be built, the IBR-2 neutron pulsed reactor with a complex of spectrometers will be upgraded, and the Multifunctional Information and Computing Complex will be modernized.

However, to ensure that JINR continue to be one of the world's leading centers for basic research in nuclear physics, it is necessary to further improve experimental facilities and implement new promising projects.

According to preliminary calculations, at least **820 million US dollars** will be needed to cover the personnel costs for a seven-year period. This amount takes into account the annual indexation of the wage fund by 4% to compensate for inflation (in ruble terms). The strategic goal is to achieve an optimal balance in the annual budget of the Institute between the costs for the development of the Institute, for the operation of basic facilities and staff costs. The optimal level for staff costs should not exceed 40–50% of the total annual budget.

Material costs for scientific themes (scientific projects and activities) are planned in accordance with the needs of JINR's scientific programme. For the further development of experimental facilities and the implementation of major scientific projects in the next seven-year period 2024–2030, **486.5 million US dollars** will be required. The most part of expenses is in the early years of the Seven-Year Plan due to the need to complete the basic configuration of the NICA accelerator complex and to modernize the DRIBs-III cyclotron complex.

In 2024–2030, the costs of maintaining and ensuring the operation of experimental facilities will increase significantly. Both material costs and electricity consumption will increase. To provide material costs for operation and maintenance of experimental facilities, including electricity, **148.3 million US dollars** are required.

The infrastructure material costs for 2024–2030 include funds for the modernization of engineering and social infrastructure, which is necessary to ensure the uninterrupted operation of experimental facilities, the operation of JINR buildings and structures, as well as the development of a comfortable social environment for the Institute's employees. These funds envisage the completion of the reconstruction of JINR power

substations, the reconstruction of engineering networks, and the implementation of projects for the development of social infrastructure.

Expenditures for the repair of buildings and facilities are planned with a slight increase for 2024–2030. This is due to the preparation of available laboratory buildings and facilities for the needs of scientific projects, as well as the need to maintain the buildings and facilities of the Institute in operational condition.

Infrastructure costs for energy and water are related to the provision of electricity, heating, water supply, and water disposal for the Institute's buildings and facilities. They are planned to increase in 2024–2030 in connection with the growth of tariffs, as well as with the commissioning of new buildings and facilities.

Material costs for administrative and economic activities are planned at the current level and hardly increase.

International cooperation costs are planned in the amount of **45.3 million US dollars**, which mainly consists of costs of holding conferences, meetings, Programme and Advisory Committees, business trips, and shows an upward trend relative to the Seven-Year Plan for 2017–2023.

Service costs are planned on the basis of current expenditure levels and do not envisage annual increases. These costs will be spent on scientific and information support, engineering and technical support, labour safety, transport costs, social costs, etc.

Extrapolation of the JINR annual budget achieved by 2023 to the period 2024–2030 will not fully meet the needs of the Institute for 2024–2030. This requires an increase in Member States' contributions in 2024–2030 of at least 5% each year, starting in 2024.



**Table 12. Specification of material costs of scientific activities**

(USD thousand)

	2024	2025	2026	2027	2028	2029	2030	TOTAL
<b>Scientific projects and activities</b>	<b>80 649,3</b>	<b>77 320,7</b>	<b>69 901,3</b>	<b>64 285,8</b>	<b>64 745,3</b>	<b>66 313,9</b>	<b>63 320,4</b>	<b>486 536,7</b>
Development of the NICA accelerator complex	36 000,0	31 700,0	32 000,0	29 300,0	29 200,0	28 900,0	24 200,0	211 300,0
Development of the DRIBs-III cyclotron complex	18 656,7	17 082,4	10 320,6	9 462,6	9 908,9	13 059,8	13 615,8	92 106,8
Development of the deep-water neutrino telescope Baikal-GVD	5 000,0	5 000,0	4 000,0	4 000,0	4 000,0	4 000,0	4 000,0	30 000,0
Development of the Multifunctional Information and Computing Complex	5 200,0	5 341,5	5 432,5	5 568,3	5 707,5	5 850,2	6 900,0	40 000,0
Development of the research nuclear facility IBR-2 and spectrometers	3 100,0	3 962,0	3 644,0	3 400,0	3 442,0	3 494,0	3 484,0	24 526,0
Development of pulsed fast reactor NEPTUNE	2 298,0	3 887,0	4 032,0	2 457,0	2 312,0	2 457,0	2 557,0	20 000,0
DLNP external projects (NOvA/DUNE, JUNO/Daya Bay, SuperNEMO, GERDA, GEMMAIII, EDELWEISS, ATLAS, etc.)	4 500,0	4 500,0	4 200,0	4 200,0	4 200,0	4 200,0	4 200,0	30 000,0
VBLHEP external projects (CMS, ALICE, NA-61, STAR, NA-64, NA-62)	2 110,0	1 920,0	2 210,0	2 210,0	2 210,0	610,0	610,0	11 880,0
LRB radiobiological projects	1 500,0	1 600,0	1 600,0	1 400,0	1 400,0	1 300,0	1 200,0	10 000,0
Development of the IREN resonance neutron source	970,0	1 000,0	1 100,0	900,0	950,0	1 000,0	1 080,0	7 000,0
Other scientific projects of FLNR (heavy ion beam research)	500,0	500,0	500,0	500,0	500,0	500,0	500,0	3 500,0
VBLHEP internal projects (CBM/HADES, SKAN3, BECQUEREL, DSS)	190,0	180,0	190,0	190,0	190,0	190,0	190,0	1 320,0
Other scientific projects of FLNP (optical methods of research)	160,0	173,0	187,0	202,0	218,0	235,0	254,0	1 429,0
MLIT intra-Institute projects (server update, jinr.ru, EDI, ADB2, PIN, etc.)	210,0	215,3	220,6	226,1	231,8	237,6	243,5	1 584,9
UC educational projects	254,6	259,5	264,6	269,8	275,1	280,3	286,1	1 890,0
<b>Maintenance and ensuring of operation of facilities (including electricity)</b>	<b>16 438,5</b>	<b>17 174,0</b>	<b>19 838,5</b>	<b>26 011,6</b>	<b>27 950,9</b>	<b>28 111,2</b>	<b>12 725,4</b>	<b>148 250,1</b>
NICA accelerator complex	7 910,0	9 102,0	10 911,0	16 215,0	17 720,0	17 717,0	2 149,3	81 724,3
Research nuclear facility IBR-2 and spectrometers	2 463,8	2 197,8	2 817,8	3 137,9	3 137,9	3 137,9	3 137,9	20 031,0
DRIBs-III cyclotron complex	2 603,7	2 322,5	2 431,7	2 873,1	3 204,8	3 255,9	3 308,3	20 000,0
Multifunctional Information and Computing Complex	1 933,6	1 986,2	2 064,1	2 145,4	2 235,9	2 331,5	2 439,0	15 135,7
Deep-water neutrino telescope Baikal-GVD	800,0	800,0	800,0	800,0	800,0	800,0	800,0	5 600,0
LINAC 200 and medical accelerator MSC-230	377,0	405,1	443,5	449,8	451,9	458,5	460,5	3 046,3
Resonance neutron source IREN	350,4	360,4	370,4	390,4	400,4	410,4	430,4	2 712,8
<b>TOTAL</b>	<b>97 087,8</b>	<b>94 494,7</b>	<b>89 739,8</b>	<b>90 297,4</b>	<b>92 696,2</b>	<b>94 425,1</b>	<b>76 045,8</b>	<b>634 786,8</b>

**Table 13. Specification of material costs for infrastructure**

(USD thousand)

	2024	2025	2026	2027	2028	2029	2030	TOTAL
<b>Modernization of engineering and social infrastructure</b>	<b>9 900,0</b>	<b>10 100,0</b>	<b>14 700,0</b>	<b>11 200,0</b>	<b>6 700,0</b>	<b>6 700,0</b>	<b>7 200,0</b>	<b>66 500,0</b>
Engineering infrastructure development projects	5 400,0	5 600,0	10 200,0	6 700,0	2 200,0	2 200,0	2 200,0	34 500,0
<i>Reconstruction of GPP-1</i>	100,0							100,0
<i>Reconstruction of GPP-2</i>	3 000,0	400,0						3 400,0
<i>Reconstruction of heating networks</i>	1 000,0	1 000,0	1 000,0	1 000,0	1 000,0	1 000,0	1 000,0	7 000,0
<i>Reconstruction of water supply and sewerage networks</i>	500,0	3 000,0	3 500,0	500,0	500,0	500,0	500,0	9 000,0
<i>Reconstruction of automatic fire safety systems</i>	800,0	700,0	700,0	700,0	700,0	700,0	700,0	5 000,0
<i>Construction of VBLHEP checkpoint</i>		500,0	5 000,0	4 500,0				10 000,0
Social infrastructure development projects	4 500,0	4 500,0	4 500,0	4 500,0	4 500,0	4 500,0	5 000,0	32 000,0
<b>Repair of buildings and structures</b>	<b>10 300,0</b>	<b>108 00,0</b>	<b>10 800,0</b>	<b>11 300,0</b>	<b>11 800,0</b>	<b>11 300,0</b>	<b>11 300,0</b>	<b>77 600,0</b>
<b>Power and water</b>	<b>5 430,4</b>	<b>5 771,6</b>	<b>6 170,6</b>	<b>6 885,9</b>	<b>7 598,8</b>	<b>7 936,8</b>	<b>8 285,3</b>	<b>48 079,4</b>
<b>Administrative-economic costs</b>	<b>6 269,3</b>	<b>6 244,8</b>	<b>6 295,4</b>	<b>6 382,7</b>	<b>6 420,6</b>	<b>6 461,4</b>	<b>6 510,9</b>	<b>44 585,1</b>
Administrative-economic costs of the Laboratories	4 269,3	4 244,8	4 295,4	4 382,7	4 420,6	4 461,4	4 510,9	30 585,1
<i>Administrative-economic costs of VBLHEP</i>	2 500,0	2 500,0	2 500,0	2 500,0	2 500,0	2 500,0	2 500,0	17 500,0
<i>Administrative-economic costs of DLNP</i>	200,0	200,0	200,0	200,0	200,0	200,0	200,0	1 400,0
<i>Administrative-economic costs of BLTP</i>	130,0	138,0	146,0	152,0	158,0	166,0	172,0	1 062,0
<i>Administrative-economic costs of FLNP</i>	542,0	490,0	500,0	500,0	500,0	510,0	520,0	3 562,0
<i>Administrative-economic costs of FLNR</i>	134,3	136,7	140,4	194,5	198,9	203,8	209,2	1 217,8
<i>Administrative-economic costs of MLIT</i>	677,3	694,3	721,9	747,8	774,0	790,5	817,5	5 223,3
<i>Administrative-economic costs of LRB</i>	81,0	81,0	82,0	83,0	84,0	84,0	85,0	580,0
<i>Administrative-economic costs of UC</i>	4,7	4,8	5,1	5,4	5,7	7,1	7,2	40,0
All-Institute administrative-economic costs	2 000,0	2 000,0	2 000,0	2 000,0	2 000,0	2 000,0	2 000,0	14 000,0
<b>TOTAL</b>	<b>31 899,7</b>	<b>32 916,4</b>	<b>37 966,0</b>	<b>35 768,6</b>	<b>32 519,4</b>	<b>32 398,2</b>	<b>33 296,2</b>	<b>236 764,5</b>

## **RISK ASSESSMENT**

### **Geopolitical risks**

JINR is one of the largest international intergovernmental scientific organizations, which is why the state of the world economy and related geopolitical processes have a significant and direct impact on the practical activities of the Institute. Currently, the world economy and politics are undergoing a period of destabilization, which may eventually lead to significant changes, and possibly to a systemic restructuring of the practices of international cooperation in various spheres of human activity, including international scientific and technical cooperation (ISTC), which have been in effect over the past decades. These geopolitical processes directly affect, to a greater or lesser extent, all JINR member states and partner countries.

The risk of possible weakening of JINR's position as an international intergovernmental organization is associated with the fact that a number of states and some international organizations have transferred the current political confrontation into the sphere of international scientific and technical cooperation in basic research, which led to a decrease in the intensity of participation of scientists from these countries and organizations in JINR research projects, and also made it difficult for JINR to participate in collaborative scientific programs of these countries and organizations.

This state of affairs in geopolitics causes certain risks for the implementation of the JINR development plan for 2024–2030. JINR's strategy to minimize and/or prevent the negative impact of the geopolitical situation will be based on strict adherence to the JINR Charter, the principles of the Sofia Declaration approved by the JINR CP at the November 2021 session, the statement of the JINR CP adopted at an extraordinary session in March 2022, on the high level of development of the Institute's research infrastructure achieved in the previous decade and the focus of the JINR scientific program on areas of unconditional interest for the world scientific community as a whole and for JINR member states and partners in particular.

Subject to the principle of reciprocity, the Institute will continue to fulfill all its obligations under the ISTC, will consistently pursue a policy of open access to its research infrastructure (Open Access) and scientific data (Open Science), strictly follow internationally recognized standards of scientific expertise and legal support of intellectual property.

Practical measures to prevent the negative consequences of geopolitical risks are described in the section "Development of JINR as an international organization". The presented set of measures is aimed at creating new and improving existing tools for expanding the JINR partner network and attracting new states to the Institute as associate and full members. Particular importance in minimizing the likelihood of the development of negative scenarios for the resolution of these risks will be given to the active strengthening of cooperation with countries that demonstrate pragmatism in their approaches to international scientific and technical cooperation, immune to fluctuations in the geopolitical conjuncture, and therefore are reliable partners in the ISTC.

### **Financial and economic risks**

The main financial risk of JINR development planning for 2024–2030, related to the geopolitical situation, is a reduction in the number of member states of the Institute and non-payment of contributions by states whose membership has been suspended for indefinite period of time, as well as incomplete and/or untimely fulfillment of their international obligations by JINR Member States. Such factors, first of all, will affect

the reduction of the JINR staff potential, the decrease in the value of its assets and competitiveness, a significant shift in the timing of achieving scientific results, which directly affect the global scientific authority of the Member States of the Institute.

Financial risks include a high forecasted inflation rate in most countries of the world, including JINR member States, which may affect the growth of prices in the field of high-tech goods and technologies, an increase in the cost of production of industrial goods, services and energy resources necessary for the implementation of scientific projects, and thereby lead to the depreciation of the monetary income of the Institute.

Of no small importance in the current economic situation in the world are the risks associated with the conclusion and execution of contracts for the supply of unique non-serial products necessary for the implementation of the scientific program of the Institute.

These factors can mainly have a significant negative impact on the ability to fully implement the program for the development and renovation of the JINR research infrastructure, lead to a distortion of the schedule and an increase in the duration of this program, insufficient financing of large engineering infrastructure projects, as well as limiting the amount of funds aimed at creating a comfortable social environment.

In order to minimize the negative impact of these factors, as well as in connection with the planned budget deficit of the 7-year development plan, measures will be applied aimed at improving budget processes, optimizing expenditures and prioritizing funding directions for the long-term development program of JINR for 2024–2030. Attracting new states with strong and/or dynamically developing economies to JINR is the most important area of work to prevent the development of negative scenarios for the implementation of financial risks. Attracting new suppliers for the procurement of unique products, in compliance with the necessary requirements for the creation of high-tech scientific facilities of the highest level, and optimizing approaches to logistics will serve to mitigate the risks associated with the execution of contracts for the supply of high-tech equipment. The proactive introduction of state-of-the-art digital technologies that reduce the costs of administrative and support processes and increase the transparency and efficiency of working with data, new convenient services that ensure the attractiveness and maximum comfort of working at JINR is already our priority goal which is being implemented.

### **The risk of personnel shortage**

The described geopolitical and financial risks determine the possibility of insufficient provision of the JINR scientific program with highly qualified scientific and engineering personnel. Systemic measures designed to prevent a shortage of personnel, or to mitigate its severity in case of occurrence, are described in the section "Strengthening human resources". The key response measures will be targeted recruitment of specialists required to perform the planned work under fixed-term employment contracts, proactive interaction with leading universities of different countries, primarily JINR member countries, in the field of personnel training, and emphasis on a significant increase in the share of associated personnel in relation to JINR staff. Despite potential economic difficulties, the development of a comfortable working and social environment is a priority.

## **MONITORING THE IMPLEMENTATION OF SEVEN-YEAR PLAN AND LONG-TERM DEVELOPMENT STRATEGY OF JINR**

Since 2021, the Portal has been functioning, which is a system of performance indicators for monitoring the Institute's activities. The system of indicators and monitoring are a key tool for analyzing the progress of solving the formulated tasks and evaluating the effectiveness of JINR's work in the main areas of activity and ensuring that the research, scientific, educational and innovative activities of the Institute comply with the latest international standards and are in demand by the JINR Member States.

The system of indicators consists of two groups of criteria. The first group characterizes the level of the Institute's ability to perceive, accumulate and produce scientific knowledge, develop research infrastructure, including virtual one, and strengthen the status of the Institute as an international intergovernmental organization. The second group characterizes the current performance in such main areas of the Institute's activities as obtaining knowledge, creating technologies, development of research infrastructure, scientific and educational activities for training highly qualified personnel for the Member States and partners of JINR, and exchange of scientific and technical information.

At the same time, each of these two groups contains the main indicators of three main types related to scientific studies and research infrastructure, the characterization of the Institute as an international intergovernmental organization, human resources potential and the current state of staff.

Currently, the Portal presents the so-called "top level" indicators – a system of qualitative and quantitative indicators that essentially characterize the Institute as a whole. The "top level" (integral) indicators will have to be supplemented with the so-called "lower level" indicators – a detailed system of characteristics, parameters and indicators within each group. The "lower level" indicators will provide more detailed information on each indicator, characterize the specifics of individual areas of activity, departments of the Institute, categories of personnel, etc.

The key task is to integrate the monitoring Portal into the Institute's common information and digital platform.